

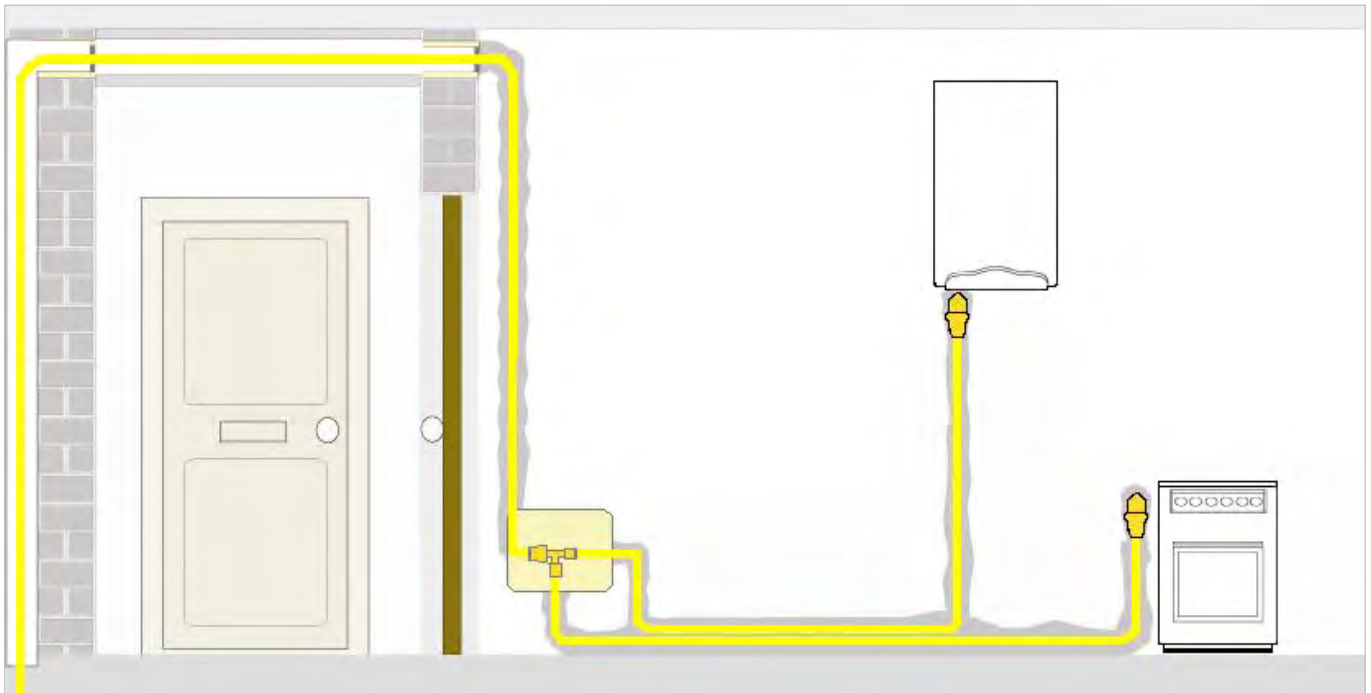

Giacomini Multigas System



MULTIGAS SYSTEM

Italian Standards UNI 7129-1:2015 and UNI 11344:2016 (concerning the features of the multilayer gas pipe and its installation in homes) indicate that the multilayer system can be used in domestic gas systems supplied from the mains distribution or fixed LPG tanks.

Systems established in compliance with these Standards are considered to be in accordance with best practice, and are therefore fully legally recognised.

As for other types of system, it is the responsibility of the installer to ensure the system is correctly set up.

Giacomini offers a complete, guaranteed Multigas System:

- G999, PEX/AL/PEX multilayer pipe - bare (\varnothing 16, 20, 26, 32 mm) or sheathed (\varnothing 16, 20, 26 mm).
- RM-GAS, press fittings with yellow O-Ring in HNBR and stainless steel bush.

Advantages of Multigas System

The advantages of the Multigas System compared with traditional gas distribution systems are:

- Safety: the system is safe and reliable, thanks to the quality of the pipe-fitting joints (guaranteed by the RM-GAS fittings);
- Speed: a quick, secure connection system;
- Losses of pressure: thanks to the RM-GAS fittings, the loss of pressure values are extremely low.

➤ Application range

The Multigas System is recommended for the installation of transfer systems supplied from the domestic gas distribution mains or from fixed LPG drums and tanks and made with multilayer metal/plastic pipes.

- Temperature range of the Multigas System (pipe and fittings): 5÷70 °C
- Maximum working pressure of the Multigas System (pipe and fittings): 0,5 bar

🔗 **NOTE.** Multigas System pipes and fittings are electrically isolated from each other thanks to a flat gasket inserted between the end part of the pipe and the brass fitting. This gasket prevents any possible contact between the two metals, thereby avoiding the risk of electrochemical corrosion.

➤ Certifications

Multigas System with KIWA UNI KIP-074976/03 certificate for multilayer metal/plastic pipe systems and fittings for internal installation for gas transportation.

➤ Reference Standards

In March 2008, Italian Ministerial Decree 37/2008 replaced Law 46/90.

The decree applies to systems inside buildings, regardless of the intended use of the building. If the system is connected to a distribution network, the decree conditions are applied from the supply point.

System design and installation must respect best practices in conformity with DM37/2008 and the indications of the guides and standards laid out by UNI, CEI or other regulatory bodies belonging to the member states of the European Union.

Starting from December 2009, UNI introduced some technical standards relating to the use of multilayer for gas transportation in domestic systems. In particular:

- **UNI 11344:2016** - multilayer metal/plastic pipe systems and fittings for transporting gaseous fuels for indoor systems.
- **UNI 7129-1:2015** - gas systems for domestic and similar use supplied by network distribution - Design, installation and commissioning.

➤ Maintenance

A check must be carried out regularly, as envisaged by UNI 11137:2012 (guideline for checking and correcting the seal of indoor systems during operation).

The system must be checked:

- if there is a persistent smell of gas;
 - if devices have been replaced;
 - if a different type of gas is being distributed;
 - if the gas system is being reactivated after more than 12 months of non-use;
 - if the outcome of the seal checks indicated by UNI 10738 is uncertain;
 - at least every 10 years (unless specified otherwise).
-
- **Clean the pipes:** close the main shut-off cock (gas meter) and detach all the cocks and hoses from the devices (open the windows). Blow compressed air into the pipes to flush out any impurities. Before reconnecting the devices, perform a system seal test.
 - **Manoeuvrability of the cocks inside the system:** it is important to check the seal and manoeuvrability of the cock (opening and closure).
 - **Check the hoses:** verify the good condition and seal of the hoses connecting the system to the devices.

G999

Multilayer pipe



G999

Multilayer pipes G999 consist of an inner PEX-b layer (polyethylene mesh), an aluminum middle layer welded lengthwise (head-head) with laser/TIG technology and an outer white PEX-b layer. The adhesive middle layers join the aluminum and PEX-b layers homogeneously. Multilayer pipes G999 is suitable for transporting gas for domestic use.

➤ Versions and product codes

Bare pipe, without sleeve

PRODUCT CODE	SIZE [mm]	PACK [m]
G999Y022	16 x 2	100
G999Y042	20 x 2	100
G999Y073	26 x 3	50
G999Y083	32 x 3	50

Pipe with sleeve

SIZE [mm]	SIZE [mm]	Ø SLEEVE [mm]	PACK [m]
G999Y024	16 x 2	Ø 26	50
G999Y044	20 x 2	Ø 30	50
G999Y074	26 x 3	Ø 36	50

➤ Technical data

- Material: PEX-b/Al/PEX-b
- Aluminium welding: head to head, with TIG method (video surveillance camera)
- Adhesive between layers: adhesion value $> 80 \text{ N/cm}^2$
- Aluminium allow:
 - treatment: annealing
 - yield: minimum value 50 MPa
 - extensibility: minimum value 30 %
 - ductility/malleability: support bends at 180°
 - widening after welding: $> 20 \%$
- Thermal expansion coefficient: $0,026 \text{ mm/m K}$
- Thermal conductivity: $0,43 \text{ W/m K}$
- Internal roughness: $0,007 \text{ mm}$
- Permeability to oxygen: 0 mg/l
- Minimum curve radius without pipe-bender:
80 mm (16x2); 100 mm (20x2); 140 mm (26x3); 160 mm (32x3)
- Minimum curve radius with pipe-bender:
50 mm (16x2); 80 mm (20x2); 100 mm (26x3); 120 mm (32x3)

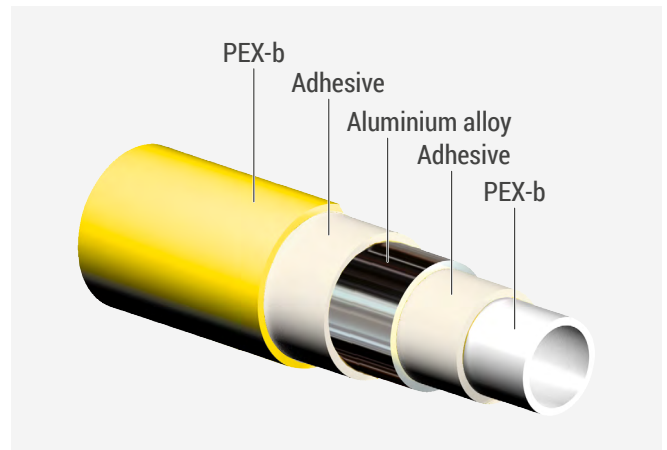

➤ Main features

- **Resistance to abrasion and corrosion:** the inner PEX layer is corrosion-proof; it is also particularly resistant to abrasion.
- **Extension:** the thermal dilation values ($0,026 \text{ mm/m K}$) are similar to those of metal pipes.
- **Mechanical behaviour:** the curve radius can vary from 2,5 to 5 times the pipe diameter, without altering the curve section. Once bent, the pipe keeps the required position just like a metal pipe.
- **Impermeability to oxygen:** the aluminium pipe forms a total barrier against gaseous molecules, thereby preventing any risk of corrosion due to oxygen infiltration or damage caused by exposure to UV rays.
- **Smooth:** the inner pipe layer has a particularly smooth surface that reduces the loss of pressure compared with metal pipes.
- **Reaction to fire:** unlikely to catch fire, thanks to the inner metal layer. In any case, the density of the smoke that develops is very low and the emissions are not harmful.
- **Thermal conductivity:** thermal conductivity is very low. Caloric dispersal is about 900 times less than that of copper.
- **Lightweight:** the G999 pipes are light and easy to transport, thanks to the low specific weight of their components. A 100 m pipe coil with $\varnothing 16 \text{ mm}$ weighs about 12 kg.
- **Unchanging over time:** extremely high ageing resistance. Simulated ageing tests performed in the lab guarantee a working lifetime for the pipe of more than 50 years.

RM-GAS series

Multitong press fittings

16x2 20x2 26x3 32x3







Multitongs press fittings made of brass, for G999 multilayer pipes of the Multigas System.
Suitable for transporting gas for domestic use.

Technical data

- Stamped brass body CW617N - EN 12165, with hose connection profile chamfered to facilitate the insertion of the pipe
- Double HNBR yellow O-Ring complying with EN 549 e EN 682, suitable for gas and liquid hydrocarbon distribution systems
- AISI 304 stainless steel compression bush, with special flaring to facilitate the insertion of the pipe
- Brass bush ring CW614N - EN 12164 with slot for visually checking the pipe is correctly and completely inserted
- Insulating separator, to avoid corrosion of an electrochemical nature due to contact with the brass of the fitting.

Main characteristics

Tongs profile

PIPE SIZE [mm]	TONGS PROFILE	
16 x 2	TH - H - U	
20 x 2	TH - H - U	
26 x 3	TH - H	
32 x 3	TH - H - U	

Multilayer pipe technical characteristics

PIPE SIZE [mm]	MEAN EXTERNAL Ø [mm]	MEAN INTERNAL Ø [mm]	THICKNESS [mm]
16 x 2	16,0 - 16,2	16,0 - 16,2	16,0 - 16,2
20 x 2	20,0 - 20,2	20,0 - 20,2	20,0 - 20,2
26 x 3	26,0 - 26,25	26,0 - 26,25	26,0 - 26,25
32 x 3	32,0 - 32,25	32,0 - 32,25	32,0 - 32,25

Fittings characteristics

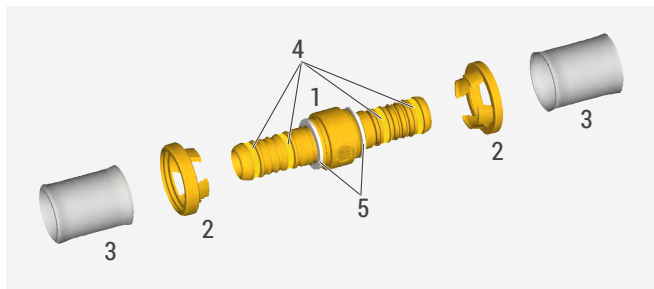

1	Brass body
2	Bush ring
3	Bush
4	O-Ring
5	Insulating separator

Bush details

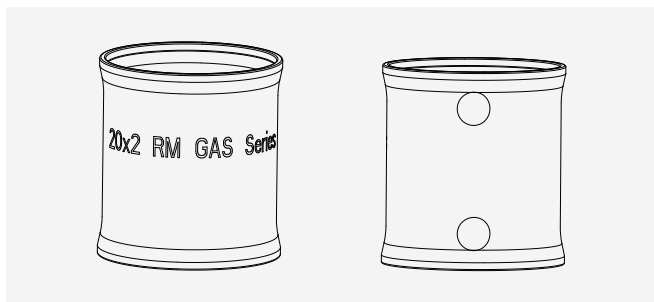

The caption "RM Series" stamped on the bush shows it can be used with various pressing profiles. Refer to the tongs profiles specified in the instructions or in "Tongs profiles" above. The size of the corresponding pipes is clearly laser-printed on the stainless steel bush. The caption RM GAS and the two yellow stamps on the bush (Ø 4,5 mm and yellow color RAL 1018) indicate the use for gas distribution.

► Installation

The Giacomini RM-GAS fittings comply with Italian Standard UNI 11344:2016 when used with the G999 multilayer pipe for gas. The following indication is printed on the pipe:

KIWA UNI KIP-074976/03 - GIACOMINI MULTIGAS - Ø "Diameter x Thickness" - MOP 0,5 GAS - PEXb-AL-PEXb - "Giacomini ID" - Made in Italy.

We recommend complying with the instructions below to prevent damage to the hydraulic sealing elements during installation and obtain an efficient joint.







- Cut the pipe 90° to its axis with a cutter (we recommend turning the cutter slightly during this operation) or a roller pipe cutter to prevent ovalizations.
- State-of-the-art seal of mechanic press fittings can be obtained only when the pipe and fitting feature corresponding nominal diameter and thickness. We recommend verifying the component dimensions before pressing to prevent improper assemblies.
- Burr and calibrate the pipe internal surface with the special tool (making sure the cutter and pipe have the same size).
- Lubricate the pipe internal surface with lubricants suitable for the system materials and use.
- Insert the pipe all the way inside the fitting; the correct coupling position of the pipe can be checked visually through the bush ring slots. The bush flared profile makes the insertion easier.
- To press the fittings, use a RP202 tong of the same size of the fitting, correctly mounted on a RP200-1 pressing tool:
 - open the tongs and make sure there are no debris inside before inserting the fitting;
 - insert the fitting in the tongs grooves matching the profiles.
 - start pressing and wait for full clamping to block the fitting.
- Verify proper fitting by looking at the bush ring to verify the correct position of the pipe. This is a one-time operation, in case of improper pressing the pipe must be cut and a new fitting is required to create the joint.







For proper long-lasting operation of the press, plan periodical revisions and keep the tongs clean and lubricated at all times to prevent anomalous stresses during pressing that may affect the mechanism duration.



NOTE. In chased fitting installations, keep the cement mixture away from the component metal parts.

We recommend an inspectionable joint, for example using a flush-mount plastic box or a box insulated from the structure and able to dilate so as to prevent chemical reactions on the metal surface and stresses by thermal dilation.

➤ Versions and product codes

SERIES	PRODUCT CODE	SIZE	FITTING TYPE
RM102-G 	RM102Y203	16 x 2	Straight
	RM102Y207	20 x 2	
	RM102Y209	26 x 3	
	RM102Y211	32 x 3	
RM103-G 	RM103Y210	(20 x 2) x (16 x 2)	Reducer straight
	RM103Y218	(26 x 3) x (20 x 2)	
	RM103Y222	(32 x 3) x (26 x 3)	
RM107-G 	RM107Y233	R 1/2" x (16 x 2)	Straight, male thread
	RM107Y237	R 1/2" x (20 x 2)	
	RM107Y247	R 3/4" x (20 x 2)	
	RM107Y249	R 3/4" x (26 x 3)	
	RM107Y259	R 1" x (32 x 3)	
RM109-G 	RM109Y233	Rp 1/2" x (16 x 2)	Straight, female thread
	RM109Y237	Rp 1/2" x (20 x 2)	
	RM109Y247	Rp 3/4" x (20 x 2)	
	RM109Y249	Rp 3/4" x (26 x 3)	
	RM109Y259	Rp 1" x (32 x 3)	
RM122-G 	RM122Y203	16 x 2	90° elbow
	RM122Y207	20 x 2	
	RM122Y209	26 x 3	
	RM122Y211	32 x 3	
RM127-G 	RM127Y233	R 1/2" x (16 x 2)	90° elbow, male thread
	RM127Y237	R 1/2" x (20 x 2)	
	RM127Y247	R 3/4" x (20 x 2)	
	RM127Y249	R 3/4" x (26 x 3)	
	RM127Y259	R 1" x (32 x 3)	

SERIES	PRODUCT CODE	SIZE	FITTING TYPE
 RM129-G	RM129Y233	Rp 1/2" x (16 x 2)	90° elbow, female thread
	RM129Y237	Rp 1/2" x (20 x 2)	
	RM129Y247	Rp 3/4" x (20 x 2)	
	RM129Y249	Rp 3/4" x (26 x 3)	
	RM129Y259	Rp 1" x (32 x 3)	
 RM139-G	RM139Y233	Rp 1/2" x (16 x 2)	90° elbow, female thread, with wall-mount bracket
	RM139Y237	Rp 1/2" x (20 x 2)	
	RM139Y249	Rp 3/4" x (26 x 3)	
 RM150-G	RM150Y203	16 x 2	Tee
	RM150Y207	20 x 2	
	RM150Y209	26 x 3	
	RM150Y211	32 x 3	
 RM151-G	RM151Y245	(16 x 2) x (20 x 2) x (16 x 2)	Reducer Tee
	RM151Y263	(20 x 2) x (16 x 2) x (16 x 2)	
	RM151Y264	(20 x 2) x (16 x 2) x (20 x 2)	
	RM151Y265	(20 x 2) x (20 x 2) x (16 x 2)	
	RM151Y267	(20 x 2) x (26 x 3) x (20 x 2)	
	RM151Y284	(26 x 3) x (20 x 2) x (20 x 2)	
	RM151Y285	(26 x 3) x (16 x 2) x (26 x 3)	
	RM151Y286	(26 x 3) x (20 x 2) x (26 x 3)	
	RM151Y289	(26 x 3) x (26 x 3) x (20 x 2)	
	RM151Y292	(32 x 3) x (26 x 3) x (26 x 3)	
RM151Y293	(32 x 3) x (26 x 3) x (32 x 3)		
 RM154-G	RM154Y233	Rp 1/2" x (16 x 2)	Tee, female thread
	RM154Y237	Rp 1/2" x (20 x 2)	
	RM154Y249	Rp 3/4" x (26 x 3)	
 RM179P-G	RM179Y253	G 1/2"F x (16 x 2)	Straight, with ISO 228 threaded flat seat nut
	RM179Y256	G 1/2"F x (20 x 2)	
	RM179Y263	G 3/4"F x (16 x 2)	
	RM179Y266	G 3/4"F x (20 x 2)	

SERIES	PRODUCT CODE	SIZE	FITTING TYPE
G139 	G139Y013	Ø 16 Ø 20 Ø 26	Shell in yellow plastic, for housing RM139-G fittings
RP200-1 	RP200Y032	A batteria 18 V	18 V battery pressing tool for press fittings, supplied in case. Include: battery charger and N°3 tongs: TH16, TH20, TH26
	RP201Y012	Batteria 18 V per RP200Y032	
RP202 	RP202Y016	Ø 16 - profilo TH	Tongs for RP200-1 pressing tool
	RP202Y017	Ø 17 - profilo TH	
	RP202Y018	Ø 18 - profilo TH	
	RP202Y020	Ø 20 - profilo TH	
	RP202Y026	Ø 26 - profilo TH	
	RP202Y032	Ø 32 - profilo TH	

➤ Dimensions

RM102-G

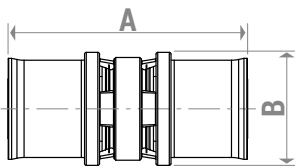

PRODUCT CODE	SIZE	A [mm]	B [mm]
RM102Y203	16 x 2	68	22
RM102Y207	20 x 2	68	26,5
RM102Y209	26 x 3	70	33
RM102Y211	32 x 3	79	39

RM103-G

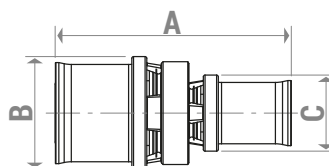

PRODUCT CODE	SIZE	A [mm]	B [mm]	C [mm]
RM103Y210	(20 x 2) x (16 x 2)	68	26,5	22
RM103Y218	(26 x 3) x (20 x 2)	69	33	26,5
RM103Y222	(32 x 3) x (26 x 3)	74	39	33

RM107-G

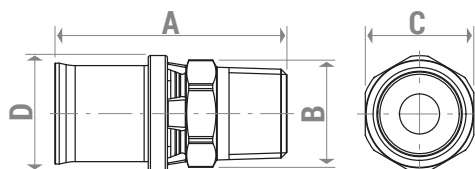

PRODUCT CODE	SIZE	A [mm]	B [mm]	C [mm]	D [mm]
RM107Y233	R 1/2" x (16 x 2)	53	24,5	22	22
RM107Y237	R 1/2" x (20 x 2)	53	24,5	22	26,5
RM107Y247	R 3/4" x (20 x 2)	55	30	27	26,5
RM107Y249	R 3/4" x (26 x 3)	56	30	27	33
RM107Y259	R 1" x (32 x 3)	65	38	34	39

RM109-G

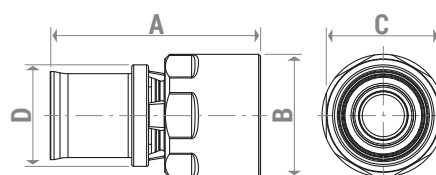

PRODUCT CODE	SIZE	A [mm]	B [mm]	C [mm]	D [mm]
RM109Y233	Rp 1/2" x (16 x 2)	50	26	24	22
RM109Y237	Rp 1/2" x (20 x 2)	50	26	24	26,5
RM109Y247	Rp 3/4" x (20 x 2)	55	32	30	26,5
RM109Y249	Rp 3/4" x (26 x 3)	56	33	30	33
RM109Y259	Rp 1" x (32 x 3)	66,5	39	36	39

RM122

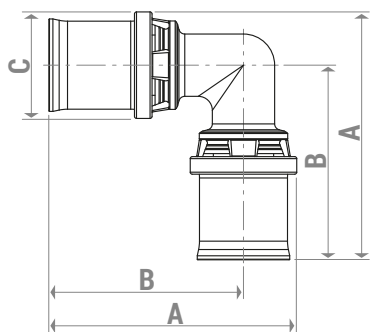

PRODUCT CODE	SIZE	A [mm]	B [mm]	C [mm]
RM122Y203	16 x 2	57,5	46,5	22
RM122Y207	20 x 2	62	48,5	26,5
RM122Y209	26 x 3	69	52,5	33
RM122Y211	32 x 3	80	60	39

RM127

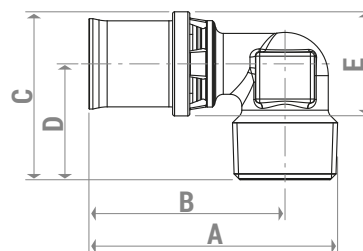

PRODUCT CODE	SIZE	A [mm]	B [mm]	C [mm]	D [mm]	E [mm]
RM127Y233	R 1/2" x (16 x 2)	57	46,5	37	26	22
RM127Y237	R 1/2" x (20 x 2)	57	46,5	41	28	26,5
RM127Y247	R 3/4" x (20 x 2)	63,5	50	43	29,5	33
RM127Y249	R 3/4" x (26 x 3)	65	51	49	32,5	33
RM127Y259	R 1" x (32 x 3)	77	60	57,5	38	39

RM129-G

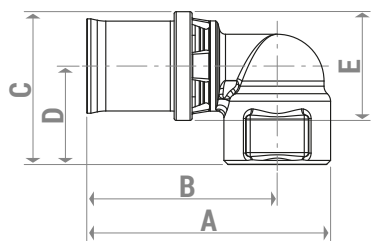

PRODUCT CODE	SIZE	A [mm]	B [mm]	C [mm]	D [mm]	E [mm]
RM129Y233	Rp 1/2" x (16 x 2)	59,5	46,5	35	24	22
RM129Y237	Rp 1/2" x (20 x 2)	59,5	46,5	37	24	26,5
RM129Y247	Rp 3/4" x (20 x 2)	67	51,5	43	30	26,5
RM129Y249	Rp 3/4" x (26 x 3)	68	52,5	46,5	30	33
RM129Y259	Rp 1" x (32 x 3)	79,5	60	54,5	35	39

RM150-G

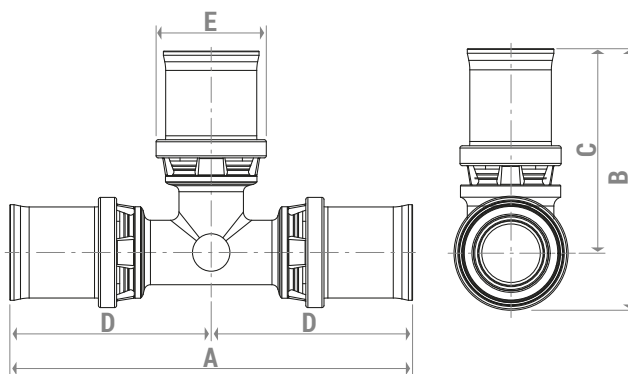

PRODUCT CODE	SIZE	A [mm]	B [mm]	C [mm]	D [mm]	E [mm]
RM150Y203	16 x 2	93	57,5	46,5	46,5	22
RM150Y207	20 x 2	97	62	48,5	48,5	26,5
RM150Y209	26 x 3	105	69	52,5	52,5	33
RM150Y211	32 x 3	120	79,5	60	60	39

RM151-G

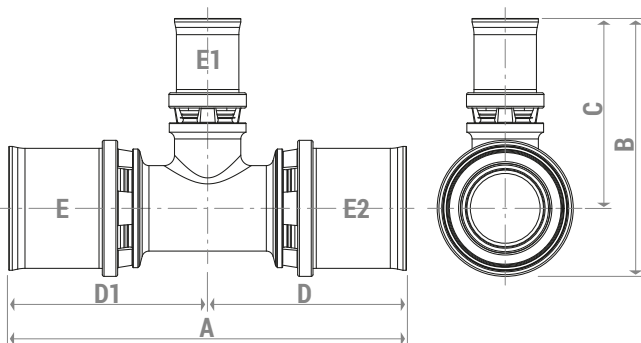

PRODUCT CODE	SIZE (ExE1xE2)	A [mm]	B [mm]	C [mm]	D [mm]	D1 [mm]
RM151Y245	(16 x 2) x (20 x 2) x (16 x 2)	97	57,5	46,5	48,5	48,5
RM151Y263	(20 x 2) x (16 x 2) x (16 x 2)	93	62	48,5	46,5	46,5
RM151Y264	(20 x 2) x (16 x 2) x (20 x 2)	93	62	48,5	46,5	46,5
RM151Y265	(20 x 2) x (20 x 2) x (16 x 2)	97	62	48,5	48,5	48,5
RM151Y267	(20 x 2) x (26 x 3) x (20 x 2)	103	63	49,5	51,5	51,5
RM151Y284	(26 x 3) x (20 x 2) x (20 x 2)	98	68	51,5	48,5	49,5
RM151Y285	(26 x 3) x (16 x 2) x (26 x 3)	95	68	51,5	47,5	47,5
RM151Y286	(26 x 3) x (20 x 2) x (26 x 3)	99	68	51,5	49,5	49,5
RM151Y289	(26 x 3) x (26 x 3) x (20 x 2)	104	69	52,5	51,5	52,5
RM151Y292	(32 x 3) x (26 x 3) x (26 x 3)	109,5	75	55,5	57	52,5
RM151Y293	(32 x 3) x (26 x 3) x (32 x 3)	114	75	55,5	57	57

RM154-G

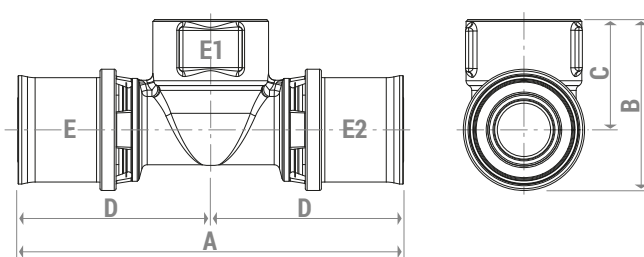

PRODUCT CODE	SIZE (ExE1xE2)	A [mm]	B [mm]	C [mm]	D [mm]
RM154Y233	(16 x 2) x Rp 1/2" x (16 x 2)	93	35	24	46,5
RM154Y237	(20 x 2) x Rp 1/2" x (20 x 2)	93	37	24	46,5
RM154Y249	(26 x 3) x Rp 3/4" x (26 x 3)	105	46,5	30	52,5

RM179SP

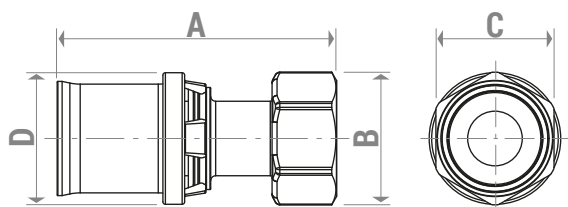

PRODUCT CODE	SIZE	A [mm]	B [mm]	C [mm]	D [mm]
RM179Y253	G 1/2" F x (16 x 2)	53	27	24	22
RM179Y256	G 1/2" F x (20 x 2)	56	27	24	26,5
RM179Y263	G 3/4" F x (16 x 2)	49	33,5	30	22
RM179Y266	G 3/4" F x (20 x 2)	53,5	33,5	30	26,5

RM139-G

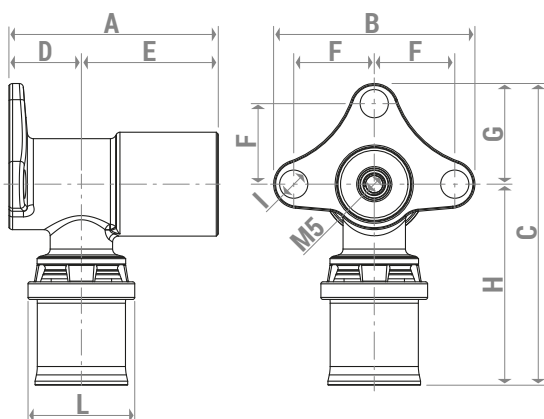

PRODUCT CODE	SIZE	A [mm]	B [mm]	C [mm]	D [mm]	E [mm]	F [mm]	G [mm]	H [mm]	I [mm]	L [mm]
RM139Y233	Rp 1/2" x (16 x 2)	52	50	75	16	36	20	25	50	7	22
RM139Y237	Rp 1/2" x (20 x 2)	52	50	75	18	34	20	25	50	7	26,5
RM139Y249	Rp 3/4" x (26 x 3)	60	50	76	20	40	20	25	51	7	33

Warranty

All products and components by Giacomini undergo a variety of quality controls as a guarantee for their high quality, certified by the quality assurance system in compliance with UNI EN ISO 9001.

All products and components by Giacomini are covered by the guarantee and liability set forth by directives 1994/44/EC, 2001/95/EC and 85/374/EEC.

The warranty will be void when:

- 1) Fittings used for distribution of fluids are not compatible with the materials.
- 2) Flaws are visually detectable upon installation or during seal testing on pressurised systems.
- 3) Installation instructions are not thoroughly complied with.
- 4) Pipes connected to the fittings feature incompatible materials or dimensions.
- 5) Fittings installed with components are not manufactured by Giacomini. The warranty covers the fittings only and not the entire system.

Product specifications

Giacomini Multigas System

The Multigas System uses the multilayer pipe of the G999 series together with the RM-GAS fittings, to create systems for transporting methane gas and LPG for domestic use.

Temperature range of the Multigas System (pipe and fittings): 5÷70 °C

Maximum working pressure of the Multigas System (pipe and fittings): 0,5 bar

KIWA UNI KIP-074976/03 certificate for multilayer metal/plastic pipe systems and fittings for internal installation for gas transportation.

G999

Multilayer PEX-b/AL/PEX-b pipe. Yellow external layer. Internal layer in PEX-b (cross-linked polyethylene), intermediate layer in aluminium welded lengthways (head-head) with TIG laser technology, external layer in PEX-b. The intermediate layers of adhesive evenly join the layer of aluminium to the layers of PE-X. The aluminium layer guarantees a firm barrier against oxygen and other gases, and also provides the product with excellent crush resistance. Suitable for transporting gas for domestic use. Thermal conductivity of the pipe 0,43 W/(m K). Coefficient of linear thermal dilation 0,026 mm/(m K). Available with diameters 16x2, 20x2, 26x3, 32x3. Also available with yellow corrugated sleeve for protection against crushing and UV rays.

Temperature range of the Multigas System (pipe and fittings): 5÷70 °C

Maximum working pressure of the Multigas System (pipe and fittings): 0,5 bar

RM102-G

Straight multitongs press fitting. Body in brass UNI EN 12165 CW617N. For multilayer pipes of the Multigas System. Double O-Ring seal in HNBR (yellow), complying with Standards EN 549 and EN 682. For gas and liquid hydrocarbon distribution systems. AISI 304 stainless steel compression sleeve with indication of the type of fitting and two yellow labels for applications in gas systems.

Pressing profile TH, H, U for Ø 16, 20, 32 mm - TH, H for Ø 26 mm. Temperature range of the Multigas System (pipe and fittings): 5÷70 °C.

Maximum working pressure of the Multigas System (pipe and fittings): 0,5 bar.

RM103-G

Reduced straight multitongs press fitting. Body in brass UNI EN 12165 CW617N. For multilayer pipes of the Multigas System. Double O-Ring seal in HNBR (yellow), complying with Standards EN 549 and EN 682. For gas and liquid hydrocarbon distribution systems. AISI 304 stainless steel compression sleeve with indication of the type of fitting and two yellow labels for applications in gas systems.

Pressing profile TH, H, U for Ø 16, 20, 32 mm - TH, H for Ø 26 mm. Temperature range of the Multigas System (pipe and fittings): 5÷70 °C.

Maximum working pressure of the Multigas System (pipe and fittings): 0,5 bar.

RM107-G

Straight multitongs press fitting with male thread. Body in brass UNI EN 12165 CW617N. For multilayer pipes of the Multigas System. Double O-Ring seal in HNBR (yellow), complying with Standards EN 549 and EN 682. For gas and liquid hydrocarbon distribution systems. AISI 304 stainless steel compression sleeve with indication of the type of fitting and two yellow labels for applications in gas systems. Pressing profile TH, H, U for Ø 16, 20, 32 mm - TH, H for Ø 26 mm. Temperature range of the Multigas System (pipe and fittings): 5÷70 °C.

Maximum working pressure of the Multigas System (pipe and fittings): 0,5 bar.

RM109-G

Straight multitongs press fitting with female thread. Body in brass UNI EN 12165 CW617N. For multilayer pipes of the Multigas System. Double O-Ring seal in HNBR (yellow), complying with Standards EN 549 and EN 682. For gas and liquid hydrocarbon distribution systems. AISI 304 stainless steel compression sleeve with indication of the type of fitting and two yellow labels for applications in gas systems. Pressing profile TH, H, U for Ø 16, 20, 32 mm - TH, H for Ø 26 mm. Temperature range of the Multigas System (pipe and fittings): 5÷70 °C.

Maximum working pressure of the Multigas System (pipe and fittings): 0,5 bar.

RM122-G

90° elbow multitongs press fitting. Body in brass UNI EN 12165 CW617N. For multilayer pipes of the Multigas System. Double O-Ring seal in HNBR (yellow), complying with Standards EN 549 and EN 682. For gas and liquid hydrocarbon distribution systems. AISI 304 stainless steel compression sleeve with indication of the type of fitting and two yellow labels for applications in gas systems.

Pressing profile TH, H, U for Ø 16, 20, 32 mm - TH, H for Ø 26 mm. Temperature range of the Multigas System (pipe and fittings): 5÷70 °C.

Maximum working pressure of the Multigas System (pipe and fittings): 0,5 bar.

RM127-G

90° elbow multitongs press fitting with male thread. Body in brass UNI EN 12165 CW617N. For multilayer pipes of the Multigas System. Double O-Ring seal in HNBR (yellow), complying with Standards EN 549 and EN 682. For gas and liquid hydrocarbon distribution systems. AISI 304 stainless steel compression sleeve with indication of the type of fitting and two yellow labels for applications in gas systems. Pressing profile TH, H, U for Ø 16, 20, 32 mm - TH, H for Ø 26 mm. Temperature range of the Multigas System (pipe and fittings): 5÷70 °C.

Maximum working pressure of the Multigas System (pipe and fittings): 0,5 bar.

RM129-G

90° elbow multitongs press fitting with female thread. Body in brass UNI EN 12165 CW617N. For multilayer pipes of the Multigas System. Double O-Ring seal in HNBR (yellow), complying with Standards EN 549 and EN 682. For gas and liquid hydrocarbon distribution systems. AISI 304 stainless steel compression sleeve with indication of the type of fitting and two yellow labels for applications in gas systems. Pressing profile TH, H, U for Ø 16, 20, 32 mm - TH, H for Ø 26 mm. Temperature range of the Multigas System (pipe and fittings): 5÷70 °C.

Maximum working pressure of the Multigas System (pipe and fittings): 0,5 bar.

RM139-G

Multitongs elbow pressure fitting with female thread, with wall support. Body in brass UNI EN 12165 CW617N. For multilayer pipes of the Multigas System. Double O-Ring seal in HNBR (yellow), complying with Standards EN 549 and EN 682. For gas and liquid hydrocarbon distribution systems. AISI 304 stainless steel compression sleeve with indication of the type of fitting and two yellow labels for applications in gas systems.

Pressing profile TH, H, U for Ø 16, 20, 32 mm - TH, H for Ø 26 mm. Temperature range of the Multigas System (pipe and fittings): 5÷70 °C.

Maximum working pressure of the Multigas System (pipe and fittings): 0,5 bar.

RM150-G

Multitongs Tee pressure fitting. Body in brass UNI EN 12165 CW617N. For multilayer pipes of the Multigas System. Double O-Ring seal in HNBR (yellow), complying with Standards EN 549 and EN 682. For gas and liquid hydrocarbon distribution systems. AISI 304 stainless steel compression sleeve with indication of the type of fitting and two yellow labels for applications in gas systems.

Pressing profile TH, H, U for Ø 16, 20, 32 mm - TH, H for Ø 26 mm. Temperature range of the Multigas System (pipe and fittings): 5÷70 °C.

Maximum working pressure of the Multigas System (pipe and fittings): 0,5 bar.

RM151-G

Reduced multitongs Tee pressure fitting. Body in brass UNI EN 12165 CW617N. For multilayer pipes of the Multigas System. Double O-Ring seal in HNBR (yellow), complying with Standards EN 549 and EN 682. For gas and liquid hydrocarbon distribution systems. AISI 304 stainless steel compression sleeve with indication of the type of fitting and two yellow labels for applications in gas systems.

Pressing profile TH, H, U for Ø 16, 20, 32 mm - TH, H for Ø 26 mm. Temperature range of the Multigas System (pipe and fittings): 5÷70 °C.

Maximum working pressure of the Multigas System (pipe and fittings): 0,5 bar.

RM154-G

Multitongs Tee pressure fitting with female thread. Body in brass UNI EN 12165 CW617N. For multilayer pipes of the Multigas System. Double O-Ring seal in HNBR (yellow), complying with Standards EN 549 and EN 682. For gas and liquid hydrocarbon distribution systems. AISI 304 stainless steel compression sleeve with indication of the type of fitting and two yellow labels for applications in gas systems.

Pressing profile TH, H, U for Ø 16, 20, 32 mm - TH, H for Ø 26 mm. Temperature range of the Multigas System (pipe and fittings): 5÷70 °C.

Maximum working pressure of the Multigas System (pipe and fittings): 0,5 bar.

RM179P-G

Straight multitongs press fitting with ISO 228 threaded nut. Flat seat connection with fibre seal gasket. Body in brass UNI EN 12165 CW617N. For multilayer pipes of the Multigas System. Double O-Ring seal in HNBR (yellow), complying with Standards EN 549 and EN 682. For gas and liquid hydrocarbon distribution systems. AISI 304 stainless steel compression sleeve with indication of the type of fitting and two yellow labels for applications in gas systems.

Pressing profile TH, H, U for Ø 16, 20, 32 mm - TH, H for Ø 26 mm. Temperature range of the Multigas System (pipe and fittings): 5÷70 °C.

Maximum working pressure of the Multigas System (pipe and fittings): 0,5 bar.

G139

Shell in yellow plastic, for housing RM139-G fittings. Complete with screws for fixing the fittings. Suitable for connecting multilayer pipes with corrugated sleeve.

⚠ Safety Warning. Installation, commissioning and periodical maintenance of the product must be carried out by qualified operators in compliance with national regulations and/or local standards. A qualified installer must take all required measures, including use of Individual Protection Devices, for his and others' safety. An improper installation may damage people, animals or objects towards which Giacomini S.p.A. may not be held liable.

♻ Package Disposal. Carton boxes: paper recycling. Plastic bags and bubble wrap: plastic recycling.

ℹ Additional information. For more information, go to giacomini.com or contact our technical assistance service. This document provides only general indications. Giacomini S.p.A. may change at any time, without notice and for technical or commercial reasons, the items included herewith. The information included in this technical sheet do not exempt the user from strictly complying with the rules and good practice standards in force.

♻ Product Disposal. Do not dispose of product as municipal waste at the end of its life cycle. Dispose of product at a special recycling platform managed by local authorities or at retailers providing this type of service.



GIACOMINI
WATER E-MOTION



Giacomini S.p.A.

Via per Alzo 39, 28017 San Maurizio d'Opaglio (NO) Italia

consulenza.prodotti@giacomini.com

+39 0322 923372 - giacomini.com