

**GX SYSTEM**



**GIACOMINI**  
WATER E-MOTION

Technical documentation

0756EN

# SUMMARY

<b>1</b>	<b>GX System</b>
<b>1</b>	<b>Advantages and features</b>
<b>1</b>	<b>Technical features - GX connection</b>
<b>2</b>	<b>Technical features - Pipes</b>
<b>6</b>	<b>Technical features - Fittings</b>
<b>8</b>	<b>Technical features - Rings</b>
<b>9</b>	<b>Technical features - Equipment</b>
<b>11</b>	<b>System installation</b>
<b>20</b>	<b>System warranty</b>
<b>20</b>	<b>Reference Standards</b>
<b>20</b>	<b>Product specifications</b>

## GX system (Giacomini eXpansion System)

Distribution system for domestic water and heating/cooling systems, both traditional and radiant, consisting in PEX-b pipes and brass fittings with a seal guaranteed by a polymeric ring. The system's water-tightness and reliability over its entire lifetime are guaranteed by the shape memory of its plastic components and the fittings' specific design.



## Advantages and features

**Pipes**, made of plastic material (PEX-b), are designed to withstand corrosion and are manufactured in compliance with the most stringent standards in order to withstand the long-term effects of **high temperature** and **pressure** of a plumbing system, in compliance with the highest hygiene standards. The **polymeric ring** has been designed to withstand expansion-related stresses during the installation phase and to **guarantee component connection** over time.

The wide range of brass **fittings** is produced using materials that comply with the highest international standards as to reliability, duration and suitability to contact with domestic water. In order to guarantee the system under pressure, Giacomini has developed a fitting profile that does not require an O-Ring. Project optimisation has allowed the development of **single range of fittings** for all usage classes and pressures.

The range of threaded fittings complies with the international standard ISO 228. The system's features support **quick installation** and this, together with the fewer components required, contributes to the **reduction of overall system costs** and greater safety.

Moreover, the use of full-port fittings and PEX-b pipes with extremely low inner roughness characteristics also determines a reduction of pressure losses for the system as a whole, thus contributing to **reduce system management costs** over the system's life time.

GX system components comply with all main standards on materials that come in contact with **domestic water**.

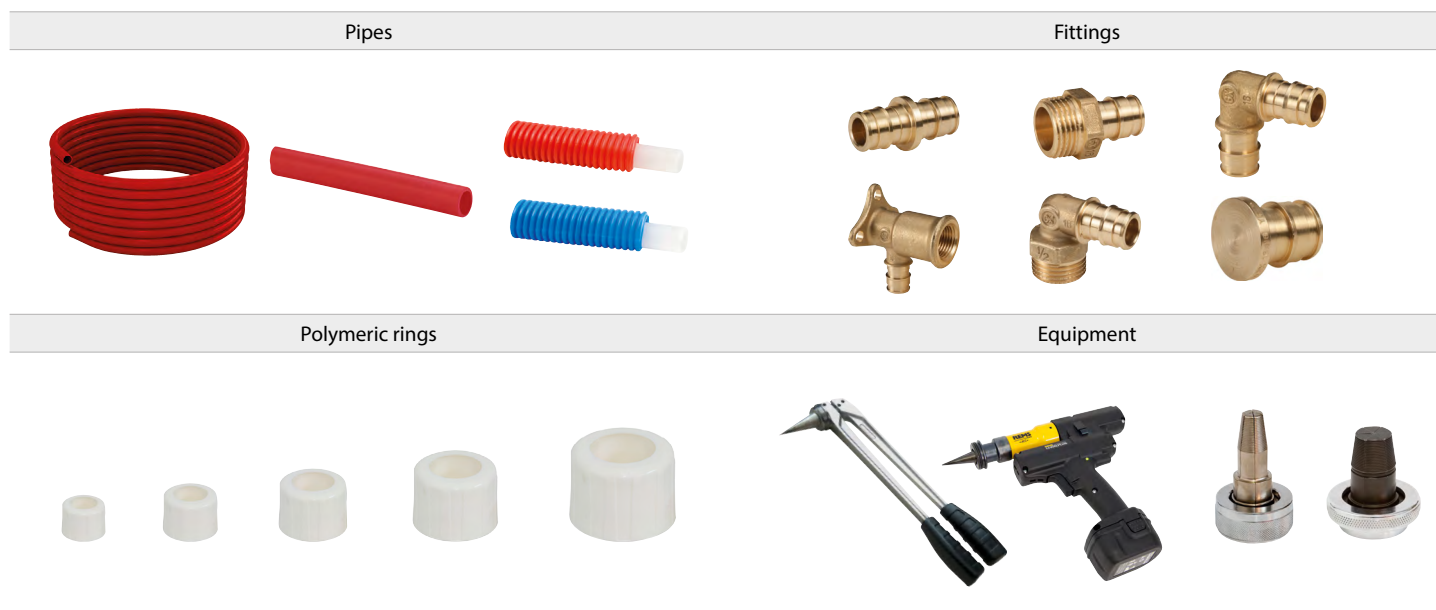

## Technical features - GX connection

In order to create system connections, the GX system relies on the memory of the plastic materials of its components, maximizing their performance thanks to the special profile of the fitting. The gradual expansion of the pipe coupled with the ring enables installers to insert the fitting, which is very quickly clamped by the force generated while the polymer components shrink back to their original shape.

At the end of the procedure, the joint has higher mechanical characteristics compared to those of the pipe alone.

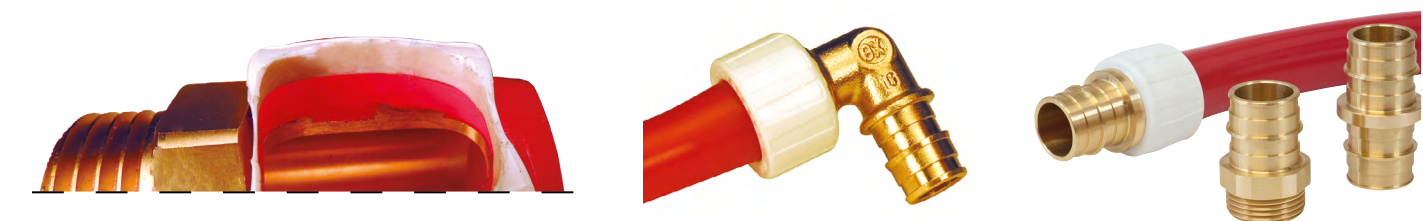

## Technical features - Pipes

### Description

The GX system high-density, cross-linked polyethylene pipes (PEX-b) enable the distribution of hot and cold domestic water and/or heating/cooling water. Water distribution via PEX-b pipes is a modern technique that offers notable advantages compared with traditional distribution systems based on iron or copper pipes including quick, easy installation with significant time savings, the possibility of avoiding welding or mechanical joints and chased mechanical joints that can result in leaks with the passing of time, as well as the long lifespan of the material that is not subject to encrustations and various electro-chemical phenomena. Other factors that cannot be ignored include the low thermal conductivity (about 100 times lower than iron and 700 times lower than copper), and the low distribution noise level thanks to the excellent acoustic insulation properties of cross-linked polyethylene.

The PEX-b pipe is particularly advantageous in water distribution systems with low pressure levels, because its limited roughness ensures low pressure losses and hence minimum flow rates in devices. The GX system also supports the creation of so-called "removable systems" using R993, R994 or R995 sleeved pipes. If the pipe is obstructed or perforated for accidental reasons, it can be quickly and easily replaced with a new one without damaging floors or walls.

### Versions and product codes

Series	Use	Product code	Dimensions [mm]	Package [m]	Anti-oxygen barrier	Pipe colour	Sleeve colour
<b>R996</b> 	Domestic plumbing systems	R996Y151	16 x 1,8	4 (in bar)	No	Neutral	No sleeve
		R996Y150	16 x 1,8	100	No	Neutral	No sleeve
		R996Y026	16 x 2,2	100	No	Neutral	No sleeve
		R996Y152	20 x 1,9	4 (in bar)	No	Neutral	No sleeve
		R996Y143	20 x 1,9	50	No	Neutral	No sleeve
		R996Y082	20 x 1,9	200	No	White	No sleeve
		R996Y032	20 x 2,8	50	No	Neutral	No sleeve
		R996Y153	25 x 2,3	4 (in bar)	No	Neutral	No sleeve
		R996Y144	25 x 2,3	50	No	Neutral	No sleeve
		R996Y154	32 x 2,9	4 (in bar)	No	Neutral	No sleeve
	R996Y146	40 x 3,7	4 (in bar)	No	Neutral	No sleeve	
	Domestic plumbing systems Heating and/or cooling systems	R996Y155	16 x 1,8	4 (in bar)	Si	Neutral	No sleeve
		R996Y140	16 x 1,8	100	Si	Neutral	No sleeve
		R996Y141	16 x 1,8	240	Si	Neutral	No sleeve
		R996Y142	16 x 1,8	600	Si	Neutral	No sleeve
		R996Y130	16 x 2,2	100	Si	Neutral	No sleeve
		R996Y156	20 x 1,9	4 (in bar)	Si	Neutral	No sleeve
		R996Y157	20 x 1,9	100	Si	Neutral	No sleeve
		R996Y131	20 x 2,8	100	Si	Neutral	No sleeve
		R996Y158	25 x 2,3	4 (in bar)	Si	Neutral	No sleeve
R996Y159		25 x 2,3	50	Si	Neutral	No sleeve	
<b>R996T</b> 	Heating and/or cooling systems	R996TY227	16 x 2,0	100	Yes	Red	No sleeve
		R996TY219	16 x 2,0	240	Yes	Red	No sleeve
		R996TY264	16 x 2,0	600	Yes	Red	No sleeve
		R996TY221	20 x 2,0	100	Yes	Red	No sleeve
		R996TY222	20 x 2,0	240	Yes	Red	No sleeve
		R996TY253	20 x 2,0	400	Yes	Red	No sleeve
		<b>R994</b> 	Domestic plumbing systems	R994Y010	16 x 1,8	50	No
R994Y026	16 x 2,2			50	No	Neutral	Red
R994Y014	20 x 1,9			50	No	White	Red
R994Y044	20 x 1,9			50	No	Neutral	Red
R994Y032	20 x 2,8			50	No	Neutral	Red
<b>R993</b> 	Domestic plumbing systems	R993Y010	16 x 1,8	50	No	Neutral	Blue
		R993Y026	16 x 2,2	50	No	Neutral	Blue
		R993Y014	20 x 1,9	50	No	White	Blue
		R993Y044	20 x 1,9	50	No	Neutral	Blue
		R993Y510	20 x 1,9	50	No	White	Blue (extra-thick sleeve)
		R993Y032	20 x 2,8	50	No	Neutral	Blue
<b>R995</b> 	Domestic plumbing systems	R995Y026	16 x 2,2	50	No	Neutral	Black
		R995Y056	16 x 2,2	75	No	Neutral	Black
		R995Y032	20 x 2,8	50	No	Neutral	Black
		R995Y062	20 x 2,8	75	No	Neutral	Black

## Advantages and features

- Pipes suitable for domestic plumbing systems (R996, R993, R994, R995) and for heating/cooling systems (R996, R996T, R993, R994, R995).
- Degree of cross-linking > 65 % because silanes cross-linking (PEX-b) is "three-dimensional" and, therefore, the molecular bond is stronger, so that the percentage required by the Standard is lower than that provided for PEX-a (> 70 %).
- Greater resistance to chlorine solutions compared to PEX-a thanks to greater density.
- Lower internal pipe roughness compared to PEX-a pipes (**lower pressure losses**).

## Technical data

GX system pipes are cross-linked with the silane method (PEX-b) and compliant with the EN ISO 15875 Standard.

The chemical cross-linking process provides mechanical, chemical and thermal characteristics that make them suitable for use, with an optimum level of quality and reliability. This method creates a product that is entirely non-toxic, making it ideal for domestic water distribution as required by Ministerial Decree 174 of 06/04/2004 for Italy.

- Application range, depending on the series: class 1, 2, 4, 5 (EN ISO 15875)
- Density: 0,94 g/cm<sup>3</sup>
- Cross-linking degree > 65% (EN ISO 15875)
- Thermal conductivity of the pipe: 0,35 W/(m K) for R996, R993, R994, R995  
0,38 W/(m K) for R996T
- Linear expansion coefficient: at 20 °C:  $1,4 \times 10^{-4}$  m/(m · K)  
at 100 °C:  $2,0 \times 10^{-4}$  m/(m · K)
- Linear dispersion of the sleeved pipe in the air (sleeve 25 mm): 0,23 W/(m · K)  
(30 mm sleeve): 0,21 W/(m · K)

## Resistance to combined pressure and temperature stress with respect to regression curves

Series (S) of pipes

$$S = \frac{d-s}{2 \cdot s}$$

Standard Dimension Ratio (SDR)

$$SDR = 2 \cdot S + 1 \approx \frac{d}{s}$$

Regression curves

$$\alpha = p \cdot \frac{d-s}{2 \cdot s}$$

where  $s$  is the nominal pipe thickness  
 $d$  is the nominal pipe diameter

where  $\alpha$  is the hydrostatic stress  
 $p$  is the induced hydrostatic pressure

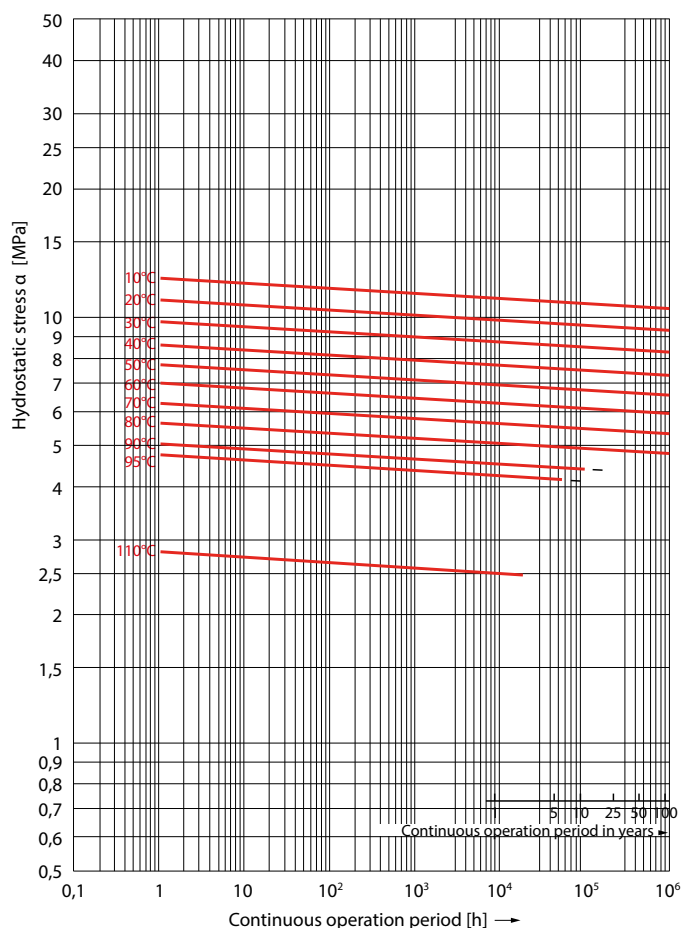

Pressure losses with 50 °C water

Flow rate [l/h]	16 x 1,8 (Øinn 12,4 mm) [kPa/m]	16 x 2,2 (Øinn 11,6 mm) [kPa/m]	20 x 1,9 (Øinn 16,2 mm) [kPa/m]	20 x 2,8 (Øinn 14,4 mm) [kPa/m]	25 x 2,3 (Øinn 20,4 mm) [kPa/m]	25 x 3,5 (Øinn 18,0 mm) [kPa/m]	32 x 2,9 (Øinn 26,2 mm) [kPa/m]	32 x 4,4 (Øinn 23,2 mm) [kPa/m]	40 x 3,7 (Øinn 32,6 mm) [kPa/m]	40 x 5,5 (Øinn 29,0 mm) [kPa/m]
36	0,013	0,024	0,003	0,008	-	-	-	-	-	-
72	0,044	0,064	0,012	0,024	-	-	-	-	-	-
108	0,090	0,128	0,023	0,049	-	-	-	-	-	-
144	0,151	0,209	0,040	0,072	-	-	-	-	-	-
180	0,225	0,313	0,059	0,113	0,019	0,035	-	-	-	-
216	0,313	0,425	0,082	0,152	0,027	0,049	-	-	-	-
252	0,413	0,554	0,109	0,201	0,036	0,063	-	-	-	-
288	0,526	0,698	0,139	0,248	0,046	0,081	-	-	-	-
324	0,656	0,858	0,171	0,305	0,056	0,100	-	-	-	-
360	0,787	1,027	0,207	0,369	0,069	0,120	0,019	0,036	-	-
720	2,736	3,490	0,723	1,236	0,237	0,416	0,067	0,123	0,023	0,042
1080	5,678	7,213	1,502	2,536	0,492	0,863	0,139	0,255	0,048	0,086
1440	9,531	12,139	2,523	4,245	0,825	1,449	0,232	0,429	0,080	0,146
1800	14,243	18,228	3,774	6,347	1,232	2,166	0,347	0,640	0,118	0,217
2160	19,777	-	5,243	8,834	1,712	3,010	0,481	0,889	0,164	0,302
2520	26,104	-	6,925	11,698	2,260	3,975	0,635	1,174	0,216	0,398
2880	33,196	-	8,811	14,931	2,877	5,059	0,081	1,494	0,275	0,506
3240	41,037	-	10,897	-	3,558	6,258	1,000	1,848	0,340	0,626
3600	-	-	13,178	-	4,305	7,572	1,210	2,235	0,412	0,757
3960	-	-	15,651	-	5,114	8,997	1,437	2,655	0,489	0,899
4320	-	-	18,311	-	5,986	10,531	1,681	3,107	0,572	1,051
5040	-	-	24,183	-	7,911	-	2,221	4,106	0,756	1,390
5760	-	-	30,771	-	10,076	-	2,829	5,228	0,962	1,769
6480	-	-	38,057	-	12,473	-	3,501	6,472	1,190	2,189
7200	-	-	46,025	-	15,099	-	4,236	7,833	1,440	2,649
7920	-	-	-	-	17,949	-	5,034	9,310	1,711	3,148
8640	-	-	-	-	21,020	-	5,895	10,902	2,003	3,685
9360	-	-	-	-	24,308	-	6,815	-	2,315	4,260
10080	-	-	-	-	27,811	-	7,796	-	2,648	4,873
10800	-	-	-	-	31,525	-	8,836	-	3,001	5,523
12600	-	-	-	-	41,725	-	11,689	-	3,969	7,306
14400	-	-	-	-	53,202	-	14,899	-	5,058	9,311
16200	-	-	-	-	-	-	18,458	-	6,264	11,533
18000	-	-	-	-	-	-	22,359	-	7,586	-
19800	-	-	-	-	-	-	26,595	-	9,022	-
21600	-	-	-	-	-	-	31,163	-	10,569	-
23400	-	-	-	-	-	-	36,057	-	12,226	-
25200	-	-	-	-	-	-	-	-	13,992	-
27000	-	-	-	-	-	-	-	-	15,866	-
28800	-	-	-	-	-	-	-	-	17,846	-
30600	-	-	-	-	-	-	-	-	19,932	-
32400	-	-	-	-	-	-	-	-	22,122	-
34200	-	-	-	-	-	-	-	-	24,415	-
36000	-	-	-	-	-	-	-	-	26,810	-

Correction factor for temperatures other than 50 °C

°C	10	15	20	25	30	35	40	45	50	55	60	65	70	75	80	85	90	95
Factor	1,208	1,174	1,144	1,115	1,087	1,060	1,039	1,019	1,000	0,982	0,965	0,954	0,943	0,928	0,923	0,907	0,896	0,878



NB.  
For pressure losses values for 16 x 2,0 and 20 x 2,0 pipes, please refer to datasheet.

## ANNEX: EN ISO 15875

### Classification of operating conditions

Performance requirements for pipe systems complying with EN ISO 15875 are specified for an operating lifespan of 50 years.

Application range	T <sub>oper</sub> [°C]	Time at T <sub>oper</sub> [years]	T <sub>max</sub> [°C]	Time at T <sub>max</sub> [years]	T <sub>mal</sub> [°C]	Time at T <sub>mal</sub> [h]
<b>CLASS 1</b> Domestic hot water (60 °C)	60	49	80	1	95	100
<b>CLASS 2</b> Domestic hot water (70 °C)	70	49	80	1	95	100
<b>CLASS 4</b> Underfloor heating and low-temperature radiators	20	plus	2,5	2,5	100	100
	40	plus	20			
	60		25			
<b>CLASS 5</b> Radiator heating at a high temperature	20	plus	14	1	100	100
	60	plus	25			
	80		10			

- Operating temperature (T<sub>oper</sub>): operating temperature envisaged for the application range, expressed in °C.
- Max. working temperature (T<sub>max</sub>): the highest value of the operating temperature, only allowed for a short period of time.
- Malfunctioning temperature (T<sub>mal</sub>): the highest temperature value that can occur when the control systems are not working (the time period possible and allowed for this value is 100 h over 50 years of continuous operation).

For each application class, maximum usage pressure can be evinced from the table below:

SIZE	PN6	CLASS 1	CLASS 2	CLASS 4	CLASS 5
16 x 1,8		8 bar	8 bar	10 bar	8 bar
16 x 2,0		not available	not available	10 bar	8 bar
20 x 2,0		not available	not available		
20 x 1,9					
25 x 2,3				8 bar	6 bar
32 x 2,9		6 bar	6 bar		
40 x 3,7					
SIZE	PN10	CLASS 1	CLASS 2	CLASS 4	CLASS 5
16 x 2,2					
20 x 2,8					
25 x 3,5				10 bar	
32 x 4,4					
40 x 5,5					



**NB:**  
For the system pressure test, please refer to the relevant paragraph on system installation.

## Technical features - Fittings

### Description





Fittings are made of CW617N (CuZn40Pb2) brass in compliance with EN12164, EN12165 and DIN50930-6 Standards and the UBA list provided for by the 4MS Initiative, so that they can also be used in domestic plumbing systems. Cooling systems must be totally insulated.

In order to guarantee the system under pressure, Giacomini has developed a fitting profile that does not require an O-Ring.







Project optimisation has allowed the development of single range of fittings for all usage classes and pressures.











The range of threaded fittings complies with the international standard ISO 228.

### Versions and product codes

Series	Product code	Size	Type of fitting
<b>GX102</b> 	GX102Y003	16 x 16	Straight
	GX102Y004	20 x 20	
	GX102Y005	25 x 25	
	GX102Y006	32 x 32	
	GX102Y007	40 x 40	
<b>GX103</b> 	GX103Y004	20 x 16	Straight reducer
	GX103Y005	25 x 16	
	GX103Y006	25 x 20	
	GX103Y008	32 x 20	
	GX103Y009	32 x 25	
	GX103Y010	40 x 25	
	GX103Y011	40 x 32	
<b>GX107</b> 	GX107Y033	16 x 1/2"M	Straight, male threaded
	GX107Y043	16 x 3/4"M	
	GX107Y034	20 x 1/2"M	
	GX107Y044	20 x 3/4"M	
	GX107Y054	20 x 1"M	
	GX107Y035	25 x 1/2"M	
	GX107Y045	25 x 3/4"M	
	GX107Y055	25 x 1"M	
	GX107Y056	32 x 1"M	
	GX107Y067	40 x 1 1/4"M	
GX107Y077	40 x 1 1/2"M		
<b>GX109</b> 	GX109Y033	16 x 1/2"F	Straight, female threaded
	GX109Y043	16 x 3/4"F	
	GX109Y034	20 x 1/2"F	
	GX109Y044	20 x 3/4"F	
	GX109Y045	25 x 3/4"F	
	GX109Y055	25 x 1"F	
	GX109Y056	32 x 1"F	
	GX109Y067	40 x 1 1/4"F	
GX109Y077	40 x 1 1/2"F		
<b>GX122</b> 	GX122Y003	16 x 16	90° elbow
	GX122Y004	20 x 20	
	GX122Y005	25 x 25	
	GX122Y006	32 x 32	
	GX122Y007	40 x 40	



Series	Product code	Size	Type of fitting
<b>GX127</b> 	GX127Y003	16 x 1/2"M	90° elbow, male threaded
	GX127Y044	16 x 3/4"M	
	GX127Y043	20 x 1/2"M	
	GX127Y055	20 x 3/4"M	
	GX127Y045	25 x 3/4"M	
	GX127Y056	25 x 1"M	
	GX127Y066	32 x 1"M	
<b>GX128</b> 	GX128X013	16 x Ø15 - L = 250 mm	90° elbow, chrome plated, with copper pipe Ø15 mm
	GX128X014	20 x Ø15 - L = 250 mm	
	GX128X073	16 x Ø15 - L = 750 mm	
	GX128X074	20 x Ø15 - L = 750 mm	
<b>GX129</b> 	GX129Y033	16 x 1/2"F	90° elbow, female threaded
	GX129Y044	16 x 3/4"F	
	GX129Y034	20 x 1/2"F	
	GX129Y045	20 x 3/4"F	
	GX129Y055	25 x 3/4"F	
	GX129Y056	25 x 1"F	
	GX129Y066	32 x 1"F	
<b>GX139</b> 	GX139Y023	16 x 1/2"F - L = 45 mm	90° elbow, female threaded, with wall support
	GX139Y003	16 x 1/2"F - L = 52,5 mm	
	GX139Y024	20 x 1/2"F - L = 45 mm	
	GX139Y004	20 x 1/2"F - L = 52,5 mm	
	GX139Y005	20 x 3/4"F - L = 52,5 mm	
	GX139Y006	25 x 3/4"F - L = 52,5 mm	
<b>R578C</b> 	R578CY002	Centre distance central holes 150 mm	Metal bracket for GX139
<b>GX150</b> 	GX150Y003	16 x 16 x 16	Tee 
	GX150Y004	20 x 20 x 20	
	GX150Y005	25 x 25 x 25	
	GX150Y006	32 x 32 x 32	
	GX150Y007	40 x 40 x 40	

Series	Product code	Size	Type of fitting
 <p>GX151</p>	GX151Y009	16 x 20 x 16	<p>Tee reducer</p> 
	GX151Y014	20 x 16 x 16	
	GX151Y015	20 x 16 x 20	
	GX151Y016	20 x 20 x 16	
	GX151Y017	20 x 25 x 20	
	GX151Y021	25 x 16 x 16	
	GX151Y022	25 x 16 x 20	
	GX151Y023	25 x 16 x 25	
	GX151Y025	25 x 20 x 20	
	GX151Y026	25 x 20 x 25	
	GX151Y028	25 x 25 x 16	
	GX151Y027	25 x 25 x 20	
	GX151Y032	32 x 20 x 20	
	GX151Y033	32 x 20 x 25	
	GX151Y034	32 x 20 x 32	
	GX151Y035	32 x 25 x 25	
	GX151Y036	32 x 25 x 32	
	GX151Y037	32 x 32 x 20	
GX151Y038	32 x 32 x 25		
GX151Y044	40 x 20 x 40		
GX151Y045	40 x 25 x 40		
GX151Y047	40 x 32 x 32		
GX151Y048	40 x 32 x 40		
 <p>GX152</p>	GX152Y041	20 x 20 x 16 x 16	4 or 5 ways manifold
	GX152Y043	20 x 20 x 16 x 16 x 16	
 <p>GX153</p>	GX153Y033	16 x 1/2" M x 16	<p>Tee, male threaded</p> 
	GX153Y034	20 x 1/2" M x 20	
	GX153Y044	20 x 3/4" M x 20	
	GX153Y045	25 x 3/4" M x 25	
	GX153Y056	32 x 1" M x 32	
 <p>GX154</p>	GX154Y033	16 x 1/2" F x 16	<p>Tee, female threaded</p> 
	GX154Y034	20 x 1/2" F x 20	
	GX154Y044	20 x 3/4" F x 20	
	GX154Y045	25 x 3/4" F x 25	
	GX154Y056	32 x 1" F x 32	
 <p>GX158</p>	GX158X013	16 x Ø15 x 16 - L = 250 mm	<p>Inclined 45°, chrome plated, with copper pipe Ø15 mm</p>
	GX158X014	20 x Ø15 x 20 - L = 250 mm	
	GX158X073	16 x Ø15 x 16 - L = 750 mm	
	GX158X074	20 x Ø15 x 20 - L = 750 mm	
 <p>GX165</p>	GX165Y003	16	Plug
	GX165Y004	20	
	GX165Y005	25	
 <p>GX179</p>	GX179Y023	16 x adaptor 16	<p>Straight, with adaptor and nut</p>
	GX179Y033	16 x adaptor 18	
	GX179Y043	16 x adaptor 1/2"	
	GX179Y053	16 x adaptor 3/4"E	
	GX179Y034	20 x adaptor 18	
	GX179Y054	20 x adaptor 3/4"E	
 <p>GX651</p>	GX651Y003	16	<p>Ball valve, red T-handle</p>
	GX651Y004	20	
	GX651Y005	25	

## Technical features - Rings

### Description

The special polymeric rings were developed to both withstand expansion-related stresses during installation and guarantee component connection over time. The ring has been designed to facilitate insertion onto the pipe, whilst the upper edge has been shaped to ensure the correct positioning of the ring during installation.

The white colour enables the system to be used also in areas other than technical rooms.

### Versions and product codes

Series	Product code	Pipe Ø [mm]	Pipe thickness [mm]
 GX61	GX61Y013	16	1,8
			2,0
			2,2
	GX61Y014	20	1,9
			2,0
	GX61Y015	25	2,8
			2,3
GX61Y016	32	3,5	
		2,9	
GX61Y017	40	4,4	
		3,7	
			5,5

### Technical data

- Suitable for all GX system pipes
- Suitable both for domestic distribution systems and heating/cooling systems
- Guarantee system seal
- Shape upper edge for pipe positioning
- White

### Materials

- Polymer material

### Main features

Polymeric rings are marked with an indication of **size**, **system** and **manufacturer** (Giacomini) at the rear.

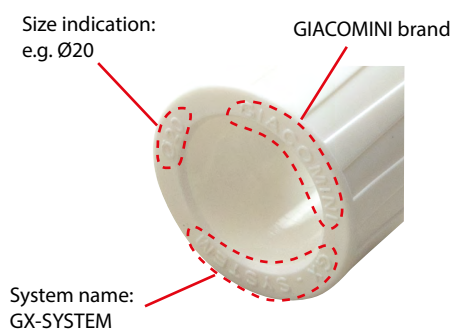

## Technical features - Equipment

### Description

GX system equipment allows the creation of all types of joints quickly and flexibly, minimising possible errors. Moreover, all types of expanders (manual, battery-operated, electrical) and adaptors for different expansion heads are available. Additionally, to reduce the effort required and ensure greater equipment life span, a dedicated lubricant for expansion cones is available.



**Warning.**

All batteries for GX system equipment must be recharged at a temperature higher than 0 °C. Lubricant grease must be applied only to the expansion cone and absolutely must not get in touch with pipes during expansion.

### Equipment choice

















Expansion type	Type of pipe	Expansion head to be used	Adaptor for expansion heads
GX200Y101 Manual expander tool	16 x 1,8	GX202Y001	-
	20 x 1,9	GX202Y002	
	25 x 2,3	GX202Y003	
GX200Y102 o GX200Y103 Manual expander tool	16 x 1,8	GX202Y011	-
	16 x 2,0	GX202Y013	
	16 x 2,2	GX202Y015	
	20 x 1,9	GX202Y016	
	20 x 2,0	GX202Y017	
	20 x 2,8	GX202Y018	
	25 x 2,3	GX202Y018	
GX200Y003 Battery powered expander tool 14,4 V	16 x 1,8	GX202Y011	-
	16 x 2,0	GX202Y013	
	16 x 2,2	GX202Y015	
	20 x 1,9	GX202Y016	
	20 x 2,0	GX202Y017	
	20 x 2,8	GX202Y018	
	25 x 2,3	GX202Y021	
	25 x 3,5	GX202Y022	
GX200Y004 Battery powered expander tool 22 V	25 x 3,5	GX202Y026	-
	32 x 2,9	GX202Y011	
	32 x 4,4	GX202Y013	
	40 x 3,7	GX202Y015	
	16 x 1,8	GX202Y016	
	16 x 2,0	GX202Y017	
	16 x 2,2	GX202Y018	
GX200Y002 Electric expander tool 230 V 50-60 Hz; 450 W; 1,8 A	20 x 1,9	GX202Y021	GX203Y001 Adaptor for electric expander tool 230 V
	20 x 2,0	GX202Y022	
	20 x 2,8	GX202Y026	
	25 x 2,3	GX202Y011	
	25 x 2,3	GX202Y013	
	25 x 3,5	GX202Y015	
	32 x 2,9	GX202Y016	
	32 x 4,4	GX202Y017	
	40 x 3,7	GX202Y018	
	40 x 3,7	GX202Y021	
GX200Y002 Electric expander tool 230 V 50-60 Hz; 450 W; 1,8 A	40 x 5,5	GX202Y027	Use the adaptor supplied with the electric expander tool

	GX202Y001	GX202Y002	GX202Y003	GX202Y011	GX202Y015	GX202Y017	GX202Y013	GX202Y016	GX202Y018	GX202Y021	GX202Y022	GX202Y026	GX202Y027	GX203Y001	GX203Y002
GX200Y101	●	●	●	●	●	●	●	●	●	●	●	●	●	●	●
GX200Y102	●	●	●	●	●	○	○	○	○	○	○	○	○	○	○
GX200Y103	●	●	●	○	○	○	●	●	●	●	●	●	●	●	●
GX200Y002	●	●	●	○	○	○	○	○	○	○	○	○	○	○	○
GX200Y003	●	●	●	○	○	○	○	○	○	○	○	○	●	●	○
GX200Y004	●	●	●	○	○	○	○	○	○	○	○	○	●	●	○

● included with kit ○ optional ● not compatible

**NB:** To create systems with the GX system, apart from the aforementioned product codes, it is also possible to use compatible equipment already available on the market. Please, contact the Giacomini Technical Service to receive a list of compatible equipment.

## Versions and product codes

Series	Product code	Expansion type	Accessories supplied as standard	Optional accessories
GX200-M 	GX200Y101	Manual expander tool	<ul style="list-style-type: none"> <li>• Expansions heads GX202Y001, GX202Y002, GX202Y003</li> <li>• Red plastic case</li> <li>• Lubricant grease GX203Y002</li> </ul>	-
	GX200Y102	Manual expander tool	<ul style="list-style-type: none"> <li>• Expansions heads GX202Y011, GX202Y015, GX202Y017</li> <li>• Black plastic case</li> <li>• Lubricant grease GX203Y002</li> </ul>	<ul style="list-style-type: none"> <li>• Expansions heads GX202Y013, GX202Y016, GX202Y018</li> </ul>
	GX200Y103	Manual expander tool	<ul style="list-style-type: none"> <li>• Expansions heads GX202Y013, GX202Y016, GX202Y018</li> <li>• Black plastic case</li> <li>• Lubricant grease GX203Y002</li> </ul>	<ul style="list-style-type: none"> <li>• Expansions heads GX202Y011, GX202Y015, GX202Y017</li> </ul>
GX200   	GX200Y003	Battery-powered expander tool 14,4 V	<ul style="list-style-type: none"> <li>• Battery and charger 230 V</li> <li>• Metal case</li> </ul>	<ul style="list-style-type: none"> <li>• Expansions heads GX202Y011, GX202Y013, GX202Y015, GX202Y016, GX202Y017, GX202Y018, GX202Y021, GX202Y022, GX202Y026</li> </ul>
	GX200Y004	Battery-powered expander tool 22 V	<ul style="list-style-type: none"> <li>• Battery and charger 230 V</li> <li>• Metal case</li> </ul>	<ul style="list-style-type: none"> <li>• Expansions heads GX202Y011, GX202Y013, GX202Y015, GX202Y016, GX202Y017, GX202Y018, GX202Y021, GX202Y022, GX202Y026</li> </ul>
	GX200Y002	Electric expander tool 230 V	<ul style="list-style-type: none"> <li>• Adaptor for expansion heads GX202Y027</li> <li>• Metal case</li> </ul>	<ul style="list-style-type: none"> <li>• GX203Y001 adaptor for expansion heads GX202Y011, GX202Y013, GX202Y015, GX202Y016, GX202Y017, GX202Y018, GX202Y021, GX202Y022, GX202Y026</li> <li>• Expansions heads GX202Y011, GX202Y013, GX202Y015, GX202Y016, GX202Y017, GX202Y018, GX202Y021, GX202Y022, GX202Y026, GX202Y027</li> </ul>
GX201	GX201Y003	Battery 14,4 V for expander GX200Y003	-	-
	GX201Y004	Battery 22 V for expander GX200Y004	-	-
GX203	GX203Y001	Adaptor for expansion heads GX202Y011, GX202Y013, GX202Y015, GX202Y016, GX202Y017, GX202Y018, GX202Y021, GX202Y022, GX202Y026	<ul style="list-style-type: none"> <li>• Cardboard box</li> </ul>	-
	GX203Y002	Lubricant grease	-	-
GX202             	GX202Y001	Expansion head Ø 16 x 1,8 mm for GX200Y101		
	GX202Y011	Expansion head Ø 16 x 1,8 mm and Ø 16 x 2,0 mm for GX200Y102, GX200Y002, GX200Y003		
	GX202Y013	Expansion head Ø 16 x 2,2 mm for GX200Y102, GX200Y002, GX200Y003		
	GX202Y002	Expansion head Ø 20 x 1,9 mm for GX200Y101		
	GX202Y015	Expansion head Ø 20 x 1,9 mm and Ø 20 x 2,0 mm for GX200Y102, GX200Y002, GX200Y003		
	GX202Y016	Expansion head Ø 20 x 2,8 mm for GX200Y102, GX200Y002, GX200Y003		
	GX202Y003	Expansion head Ø 25 x 2,3 mm for GX200Y101		
	GX202Y017	Expansion head Ø 25 x 2,3 mm for GX200Y102, GX200Y002, GX200Y003		
	GX202Y018	Expansion head Ø 25 x 3,5 mm for GX200Y102, GX200Y002, GX200Y003		
	GX202Y021	Expansion head Ø 32 x 2,9 mm (type H) for GX200Y002, GX200Y003		
	GX202Y022	Expansion head Ø 32 x 4,4 mm (type H) for GX200Y002, GX200Y003		
	GX202Y026	Expansion head Ø 40 x 3,7 mm (type H) for GX200Y002, GX200Y003		
GX202Y027	Expansion head Ø 40 x 5,5 mm for GX200Y002			
R990	R990Y001	Cutter for Ø 16, 20, 25 mm plastic pipes	-	-
H201	H201Y001	Cutter for Ø 32, 40 mm plastic pipes	-	-



NB: For cutting the pipes you can also use a standard roller pipe cutter.

## System installation



### WARNING - READ CAREFULLY

- Pipe expansion and fitting insertion operations must be carried out at the same location, since fittings must be installed immediately after pipe expansion.
- Temperature during installation of the GX system must be higher than -15 °C. It is advisable to work between 5÷25 °C.
- The installation must be carried out by skilled, qualified personnel.

To install the GX system, proceed as follows:

### 1) Pipe cut

Square-cut the pipe perpendicularly to its axis, using the R990 cutter and taking care not to deform it **(1.1)**.

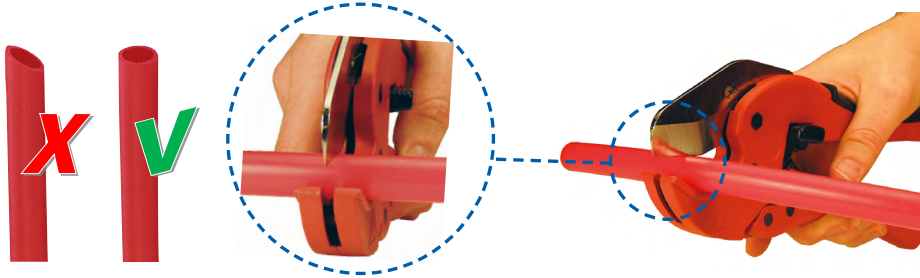

1.1

### 2) Ring insertion

Insert the plastic rings onto the pipe **(2.1)**, making sure that the pipe reaches the upper edge **(2.2)**.

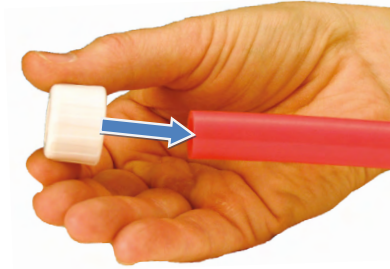

2.1

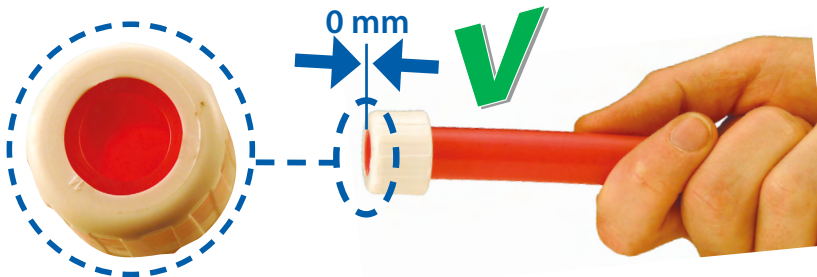

2.2

### 3) Expander tool preparation

Prepare the expander tool by screwing on the appropriate expansion head **(3.1)**, based on pipe diameter (for the choice of the right equipment, please refer to paragraph "Technical features - equipment").



3.1



## WARNING - READ CAREFULLY

Before proceeding, you are advised to **read the entire text for steps 4 and 5**, since step 5 must be carried out **immediately** after step 4.

### 4a) Pipe expansion... ...with **MANUAL EXPANDER TOOL**

Insert the open expander tool, complete with expansion head, into the pipe up until possible, without forcing it (4a.1).

Close the expander tool to widen the pipe. The expansion head will perform some expansion steps that will widen the pipe (4a.2). At the end of each expansion of the expansion head, manually rotate the pipe/or the expander tool by min. 10° - max. 45° and insert it deeper into the head (4a.3).

Follow these steps until the expansion head is completely inside the pipe (4a.4), then perform at least further 2 expansions.

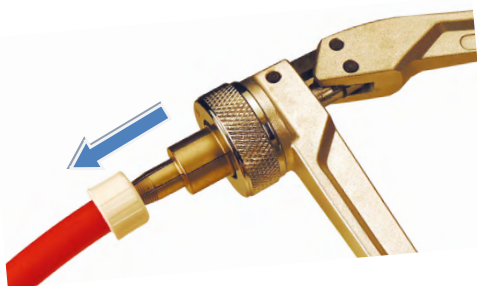

4a.1

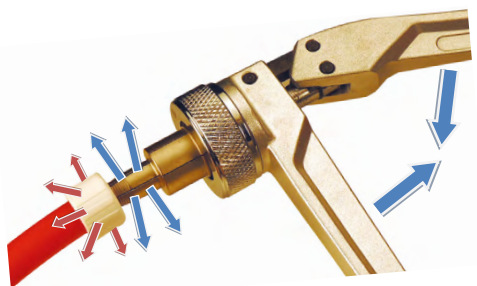

4a.2

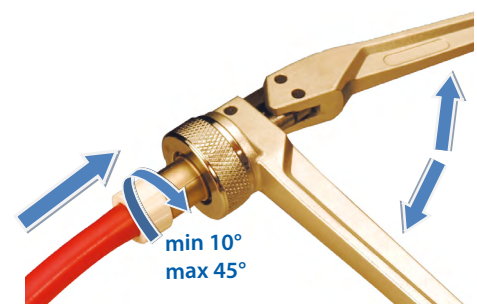

4a.3

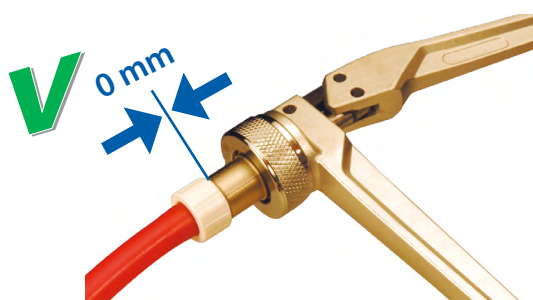

4a.4

### 4b) Pipe expansion... ...with **ELECTRIC OR BATTERY EXPANDER TOOL**

Insert the open expander tool, complete with expansion head, into the pipe up until possible, without forcing it (4b.1).

Start the expander tool. The expansion head will perform some expansion steps that will widen the pipe (4b.2). At the end of each expansion step of the expansion head, manually rotate the pipe/or the expander tool by min. 10° - max. 45° and insert it deeper into the head (4b.3).

Follow these steps until the expansion head is completely inside the pipe (4b.4), then perform at least further 2 expansions (for Ø 32 x 4,4 mm and 40 x 5,5 mm pipes, perform at least further 6 expansions).

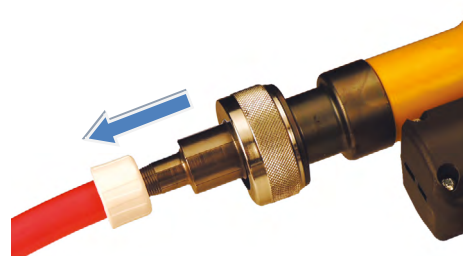

4b.1

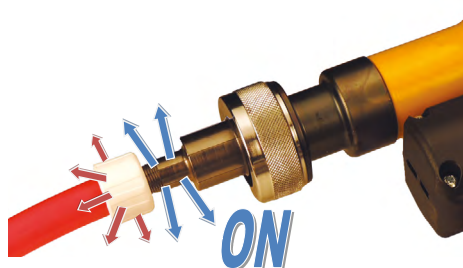

4b.2

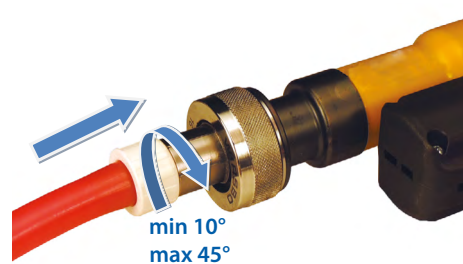

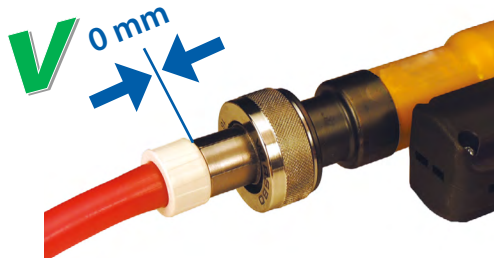

4b.3



4b.4

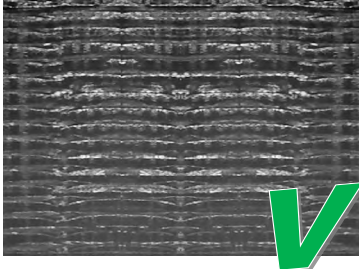
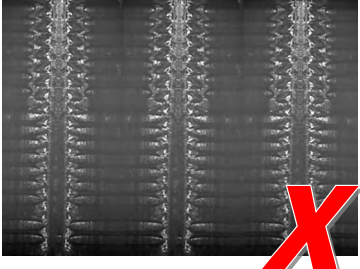

 <p><b>WARNING - READ CAREFULLY</b> During the <b>4a.3/4b.3</b> step, it is important to remember to rotate the pipe or the expander tool by min. 10° - max. 45°. This to prevent irregular expansion of the pipe.</p>	<p style="text-align: center;">REGULAR EXPANSION</p> 	<p style="text-align: center;">IRREGULAR EXPANSION</p> 
--	---	--

	<p><b>Warning.</b> If, during the expansion stage, the process is interrupted, the part of the pipe and the ring used <b>must</b> be cut. To make a new connection make sure to avoid using damaged or deformed components. You should use new ring and pipe length.</p>
--	--

### 5) Fitting insertion

**Immediately** insert the GX fitting inside the pipe that has just been widened. Make sure that the ring is flush with the fitting's shoulder (**5.1**). The previously widened ring and pipe will start to shrink on the fitting. After 1 minute the joint will be complete and it will be possible to move on to the following connection (**5.2**).

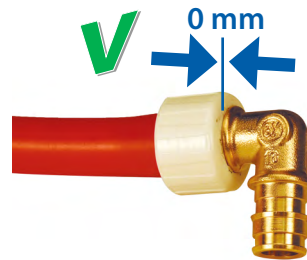
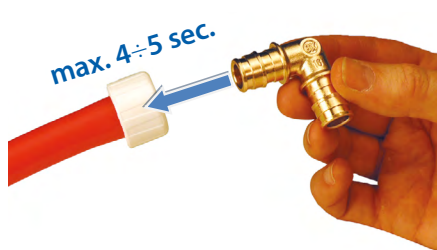

5.1

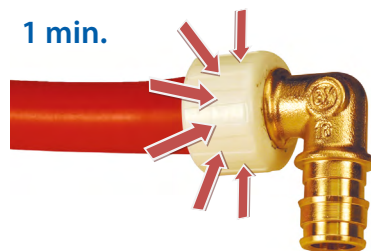

5.2



## Fitting recovery

If the fitting was not correctly inserted (**a**), it is possible to reuse it after removing the ring and the pipe, following the procedure below:

- Cut the ring with a Stanley knife, making sure to avoid cutting the pipe (**b**).
- Remove the ring from the pipe, manually widening it (**c**).
- Make longitudinal cuts on the pipe, at a distance of approx. 1 cm from each other (**d**), paying attention **not to damage the brass fitting** underneath it.
- Remove the pipe by flexing it manually, so as to widen it sufficiently to slide it away (**e**) (it is possible to heat the pipe with hot air to facilitate its removal).
- If you need to insert the fitting again in the same pipe, make sure that the previously deformed pipe length is removed.

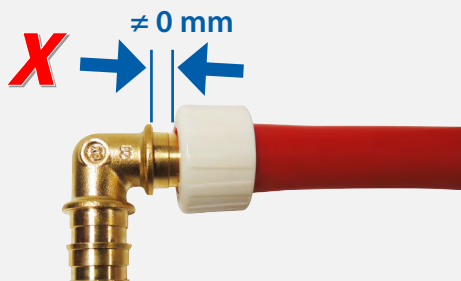

a



b

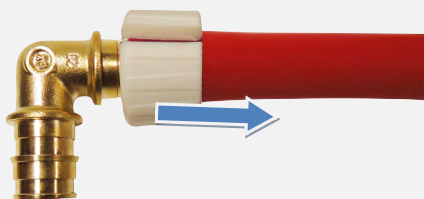

c

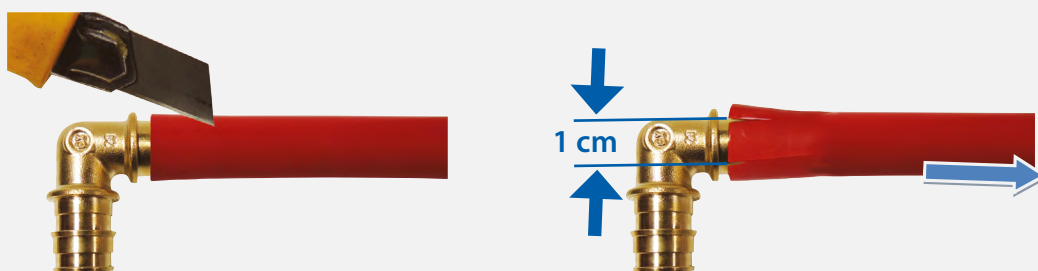

d

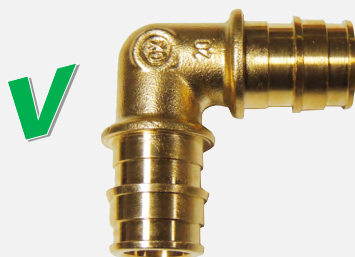

e



### Warning.

Do not execute joints on pipe lengths that have been deformed or damaged.

## 6) Pipe laying

GX system pipes enable the creation of plumbing systems with extreme ease and speed.

During the laying process, some simple precautions must be observed with respect to pipe connection thanks to special fittings and adaptors, pipe bends, protection against UV rays and against any possible damage involving the pipe or its protective sleeve.

- The connection of pipes to distribution manifolds or elbows for tap coupling must be executed using fittings and adaptors of the right size for that specific pipe.
- Pipe laying, fixing and connections have to be realized thus to avoid permanent mechanical stress on components.
- All materials used to manufacture pipes expand when they are heated and shrink when they are cooled: for this reason longitudinal change ( $\Delta L$ ) generated by temperature change should always been considered during installation.

The difference in temperature and pipe length are the two parameters that determine longitudinal change ( $\Delta L$ ).

Longitudinal change can be calculated with the following formula:  $\Delta L = L \times \alpha \times \Delta T$  where:

$\Delta L$  = pipe longitudinal change in mm

L = pipe length in mm

$\alpha$  = linear expansion coefficient (the linear expansion coefficient is  $1,4 \times 10^{-4} \text{ m}/(\text{m} \cdot \text{K})$ , independently from pipe diameter)

$\Delta T$  = maximum temperature difference in the system in °C

Example: L = 5 m

$$\alpha = 1,4 \times 10^{-4} \text{ m}/(\text{m} \cdot \text{K})$$

$$\Delta T = 63 \text{ }^\circ\text{C} \text{ (where } T_{\text{min}} = 7 \text{ }^\circ\text{C} \text{ and } T_{\text{max}} = 70 \text{ }^\circ\text{C)}$$

$$\Delta L = 5000 \times 0,00014 \times 63 = 44 \text{ mm}$$

- For surface installation, pipe length must be calculated on the basis of system requirements and distances between pipe supports must be carefully evaluated. Maximum distance between each support (L) depends on the diameter of the pipe used.

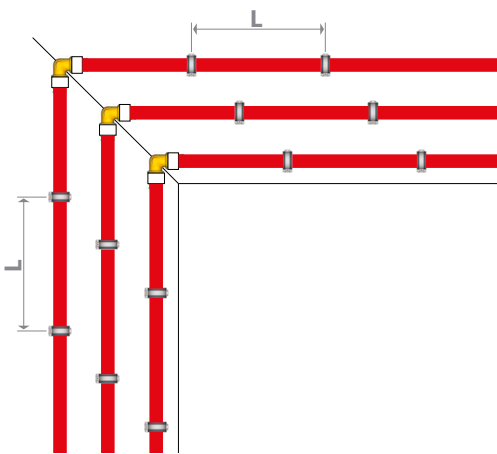

Pipe external Ø	Max. distance between supports (L)
16 mm	80 cm
20 mm	120 cm
25 mm	150 cm
32 mm	160 cm
40 mm	170 cm

- Supports used in surface installations have the two key functions of supporting the pipe and allowing its thermal expansion. Supports can be **fixed**, clamping the pipe; or **sliding**, permitting the pipe to slide as a result of thermal expansion.

Fixed support

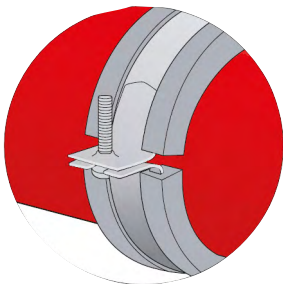

Sliding support

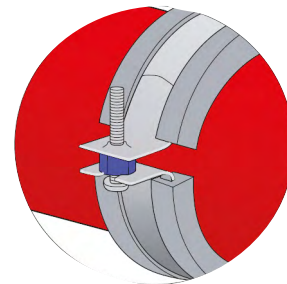

**Warning.**

Secure the pipe with the aid of plastic ties. Avoid using metal ties without protection, as they could damage the pipe.

- In long straight pipe stretches, to absorb any length changes, it is advisable to insert at least one expansion bend **every 10 m**. For pipes with a diameter equal to or greater than 32 mm, expansion bends are mandatory.

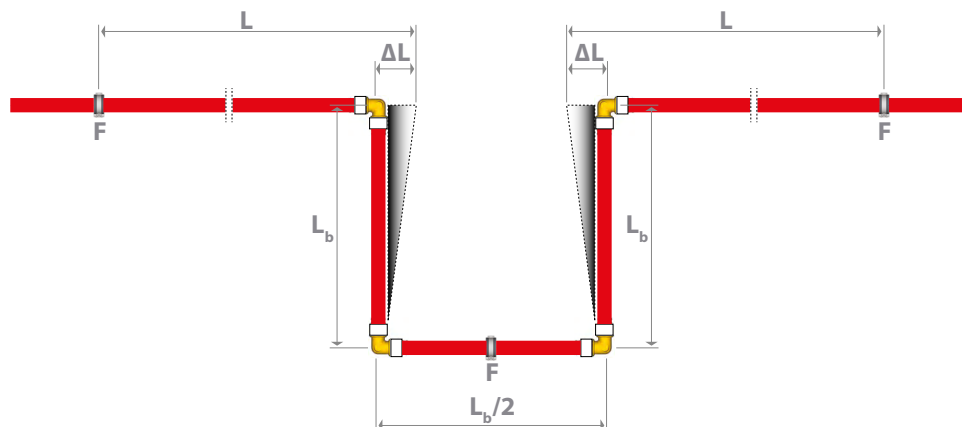

## Legend

L	Distance between fixed support and expansion bend	F	Fixed support
ΔL	Pipe longitudinal change	L <sub>b</sub>	Length of the expansion bend

Minimum length of expansion bend ( $L_b$ ) can be calculated with the following formula:  $L_b = C \times \sqrt{(\varnothing_e \times \Delta L)}$  where:

$L_b$  = minimum length of the expansion bend in mm

C = constant of material (for PEX pipe the value is 33)

$\varnothing_e$  = pipe external diameter in mm

$\Delta L$  = pipe longitudinal change in mm

Example: L = 5 m

$$\varnothing_e = 25 \text{ mm}$$

$$\alpha = 1,4 \times 10^{-4} \text{ m}/(\text{m} \cdot \text{K})$$

$$\Delta T = 63 \text{ }^\circ\text{C} \text{ (dove } T_{\text{min}} = 7 \text{ }^\circ\text{C e } T_{\text{max}} = 70 \text{ }^\circ\text{C)}$$

$$\Delta L = 5000 \times 0,00014 \times 63 = 44 \text{ mm}$$

$$L_b = 33 \times \sqrt{25 \times 44} = 1094,5 \text{ mm}$$

- When bends are required, it is fundamental to use fittings and fix/sliding supports correctly, as per the following drawing. It is advisable to fit an expansion bend each time the pipe changes direction also considering to have clearance around.

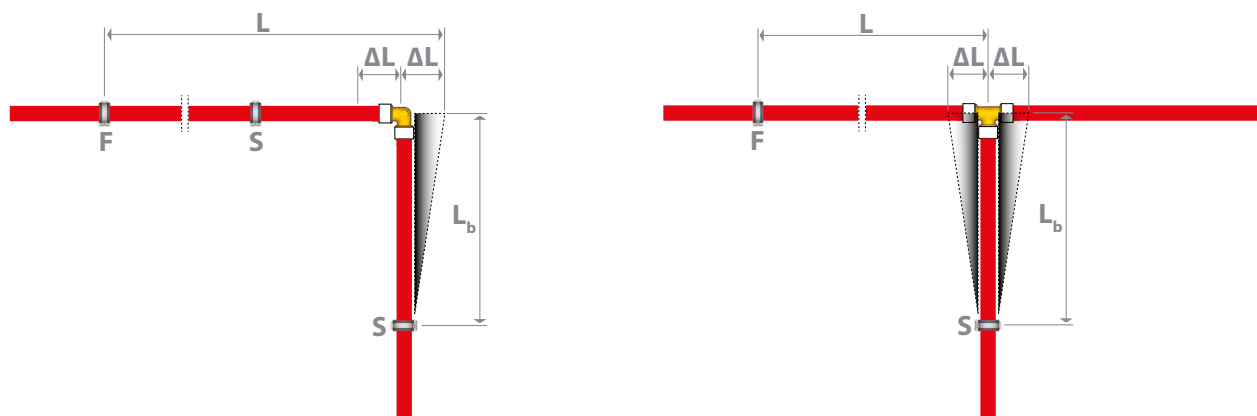

## Legend

L	Distance between fixed support and expansion bend	F	Fixed support
ΔL	Pipe longitudinal change	S	Sliding support
L <sub>b</sub>	Length of the expansion bend		

- The bend radius during the installation of pipes with  $\varnothing$  16, 20 and 25 mm must be greater than 8 times the pipe's outer diameter; such value can drop to 5 times the pipe's outer diameter only if the dedicated **R549P** bend support is used.
- The bend radius during the installation of pipes with  $\varnothing$  32 and 40 mm must be greater than 15 times the pipe's outer diameter;
- The bend can be applied either with the cold or the hot method, with the aid of hot air (max 100 °C).
- Pipes must not be heated with a naked flame or heat sources with temperatures so high to cause the pipe melting.

- The "removability" of R993, R994 and R995 series pipes is only guaranteed if the bends have a minimum radius greater than 8 times the outer pipe diameter.
- Pipes and fittings that have already been assembled must not be bent.  
If bending cannot be avoided for technical reasons, the area of the pipe near the fitting must not be subjected to permanent stresses.
- Two consecutive fittings must be installed at such a distance so as not to generate reciprocal stresses on all components, both during system installation and operation.
- In installations pipe must always be protected from UV rays and fluorescent lights that could alter its chemical-physical properties.
- Make sure the pipe is not exposed to solar radiation or fluorescent lights for long periods.
- If the pipe is chased without a protective sleeve, it has to be covered with at least 15 mm thick screed to prevent cracking of the plaster due to thermal expansion.
- Avoid chasing fittings as much as possible. If this is not possible, make sure the fitting can be inspected or protect it from contact with building material and make a note of its position in the project documentation.
- After installing the pipes and before covering them, it is advisable to test the system under pressure, so as to immediately identify any leaks (see paragraph "Pressure test").
- Following the pressure test, the sleeves must be protected by encasing them with cement so that the pipes cannot be crushed or moved.
- Do not allow ice to form, as the expansion caused by the change of status could damage the pipe.
- If a damaged pipe must be replaced, use the dedicated **R576** series joint, following the steps in the relevant instructions.

#### **Storage precautions**

- Store the pipe in a dry, protected area to avoid dampness-related damage to the packaging.
- Keep the pipe in its packaging, avoiding any exposure to direct sunlight.
- Pay special attention during the transport and installation stages.
- Make sure the pipe does not come into contact with sharp objects that could scratch it.
- Do not allow ice to form, as the expansion caused by the change of status could damage the pipe.
- Make sure the pipe does not come into contact with a naked flame or heat source with a temperature over 100 °C.
- Make sure the pipe does not come into contact with chemical solvents or paints.

## 7) Pressure test

The pressure test must be carried out for all GX system installations before commissioning.

The system can be put under water pressure after 30 minutes at  $\geq 5\text{ }^{\circ}\text{C}$  temperatures (for lower temperatures, see table 1).

Maximum test pressure, which cannot be exceeded, is 15 bar (1,5 MPa; 200 psi).

After 24 h, at  $23\text{ }^{\circ}\text{C}$  the joint has a strength equal to that of the pipe.

The pressure test procedure is:

- 1) Remove the air from the system and put it under water pressure at 0,5 bar.
- 2) If there are no leaks after 15 minutes, increase the pressure to 1,5 times the operating pressure and keep it at this level for 30 minutes, visually inspecting the joints.
- 3) Reduce the pressure to 0,5 times the operating pressure and keep it at this level for 90 minutes:
  - if the pressure remains constant or increases slightly, it means that the systems does not leak;
  - if the pressure decreases, it means there is a leak in the system.

Temperature range	Waiting time before pressure test
$> 5\text{ }^{\circ}\text{C}$	0,5 h
$0 \div 5\text{ }^{\circ}\text{C}$	1,5 h
$0 \div -5\text{ }^{\circ}\text{C}$	3,0 h
$-5 \div -10\text{ }^{\circ}\text{C}$	4,0 h
$-10 \div -15\text{ }^{\circ}\text{C}$	10,0 h

Table 1

### Examples of pressure tests

#### Example for Class 1, 2, 5 system

Operating pressure = 6 bar

Initial test pressure: 0,5 bar [for 15 min.]

Test pressure after 15 min.:  $6 \cdot 1,5 = 9$  bar [for 30 min.]

Test pressure after 45 min.:  $6 \cdot 0,5 = 3$  bar [for 90 min.]

Pressure  $\geq 3$  bar ( $6 \cdot 0,5$ ) = the system does not leak

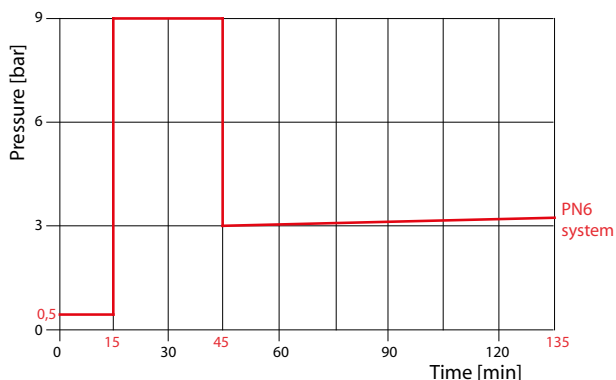

#### Example for Class 1, 2, 4, 5 system

Operating pressure = 8 bar

Initial test pressure: 0,5 bar [for 15 min.]

Test pressure after 15 min.:  $8 \cdot 1,5 = 12$  bar [for 30 min.]

Test pressure after 45 min.:  $8 \cdot 0,5 = 4$  bar [for 90 min.]

Pressure  $\geq 4$  bar ( $8 \cdot 0,5$ ) = the system does not leak

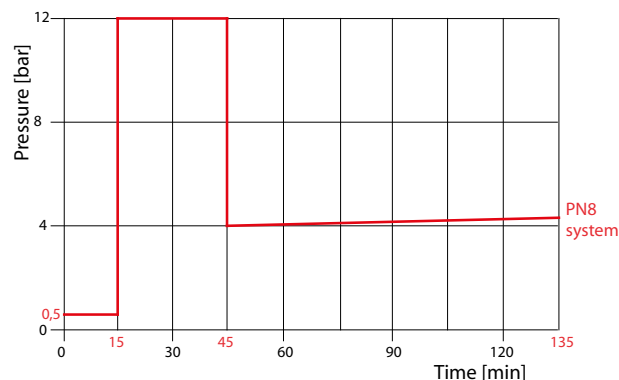

#### Example for Class 1, 2, 4, 5 system

Operating pressure = 10 bar

Initial test pressure: 0,5 bar [for 15 min.]

Test pressure after 15 min.:  $10 \cdot 1,5 = 15$  bar [for 30 min.]

Test pressure after 45 min.:  $10 \cdot 0,5 = 5$  bar [for 90 min.]

Pressure  $\geq 5$  bar ( $10 \cdot 0,5$ ) = the system does not leak

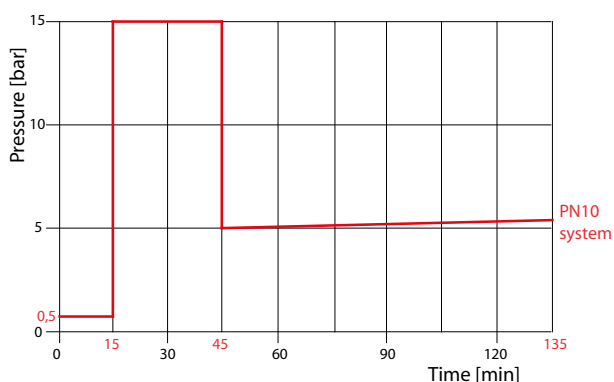

**NB:**

For system classes, refer to Annex EN ISO 15875, paragraph "Technical features - Pipes".

## System warranty

All products and components supplied by Giacomini are subjected to numerous tests in order to guarantee the high quality in compliance with UNI EN ISO 9001 certification of the Company's Quality Management System.

All products and components supplied by Giacomini are covered by the warranty and liabilities provided for in Directives 1994/44/EC, 2001/95/EC and 85/374/EEC.

The warranty does not apply to the following cases:

- 1) if the GX system is used to distribute fluids that are not compatible with its materials;
- 2) if there are any visible faults at the time of installation or during the system's pressure test;
- 3) if installation instructions are not carefully followed;
- 4) if the pipes connected to the fittings are made of non-compatible materials or have non-compatible dimensions;
- 5) if the GX system is installed using components or equipment not compatible or not manufactured by Giacomini.

## Reference Standards

- EN ISO 15875 Plastic piping systems for hot and cold water installations.
- DIN 16892 Plastic piping systems - Technical requirements.
- DIN 4726 Plastic piping systems - Technical requirements.

## Product specifications

Distribution system for domestic water and/or heating/cooling systems, both traditional and radiant, consisting in PEX-b **pipes** and brass **fittings** with a seal guaranteed by a **polymeric ring**.

GX system pipes are cross-linked with the silane method (PEX-b) and compliant with the EN ISO 15875 Standard; the pipes indicated as suitable for the distribution of domestic water are in compliance with Ministerial Decree 174 of 06/04/2004 for Italy; application range: class 1, 2, 4 and 5 (EN ISO 15875) depending on the series.

Fittings are made of CW617N (CuZn40Pb2) brass in compliance with EN12164, EN12165 and DIN50930-6 Standards and the UBA list provided for by the 4MS Initiative, so that they can also be used in domestic water systems. Cooling systems must be totally insulated. The range of threaded fittings complies with the international standard ISO 228. Polymeric rings are suitable for all GX system pipes, both for domestic distribution systems and heating/cooling systems; the ring design is characterised by an upper edge shaped in such a way as to ensure the correct positioning on the pipe during installation. The system is completed by a wide range of dedicated equipment (manual, battery-operated and electric expander tools; expansion heads).

**NB:**

The product codes mentioned in this technical document may be changed without any notice.  
Check available product codes in the most up-to-date product catalogue.

### Additional information

For additional information please check the website: [www.giacomini.com](http://www.giacomini.com) or contact the technical service: ☎ +39 0322 923372 📠 +39 0322 923255 ✉ [consulenza.prodotti@giacomini.com](mailto:consulenza.prodotti@giacomini.com)  
This pamphlet is merely for information purposes. Giacomini S.p.A. retains the right to make modifications for technical or commercial reasons, without prior notice, to the items described in this pamphlet. The information described in this technical pamphlet does not exempt the user from following carefully the existing regulations and norms on good workmanship.  
Giacomini S.p.A. Via per Alzo, 39 - 28017 San Maurizio d'Opaglio (NO) Italy





---

**⚠ Safety Warning.** Installation, commissioning and periodical maintenance of the product must be carried out by qualified operators in compliance with national regulations and/or local standards. A qualified installer must take all required measures, including use of Individual Protection Devices, for his and others' safety. An improper installation may damage people, animals or objects towards which Giacomini S.p.A. may not be held liable.

**♻ Package Disposal.** Carton boxes: paper recycling. Plastic bags and bubble wrap: plastic recycling.

**ℹ Additional information.** For more information, go to [giacomini.com](http://giacomini.com) or contact our technical assistance service. This document provides only general indications. Giacomini S.p.A. may change at any time, without notice and for technical or commercial reasons, the items included herewith. The information included in this technical sheet do not exempt the user from strictly complying with the rules and good practice standards in force.

**♻ Product Disposal.** Do not dispose of product as municipal waste at the end of its life cycle. Dispose of product at a special recycling platform managed by local authorities or at retailers providing this type of service.

---