



Description

In today's society, the search for well-being has become a fundamental factor. One of the problems regarding well-being in the home lies in managing the temperatures of the individual rooms according to how they are used. It's essential for the user to be able to decide the best temperatures for the rooms where he/she lives or works, thereby obtaining energy savings as well. To reach these results, you need temperature adjustment systems that optimise the potential of the system, exploiting the free energy supplies. During the day, the rooms of the home are subject to thermal loads that change on the basis of various factors including any sudden variation in the outdoor temperature, indoor supplies of free energy due for example to the presence of people, electrical equipment, or solar radiation via the windows. In these situations, an automatic adjustment tool like the thermostatic head fitted on the heating element prevents the risk of excess temperatures. It does this by excluding the radiator of that room from the rest of the system (so the room is not actually heated), while energy continues to be supplied as usual throughout the rest of the home.

For all new/renovated buildings and thermal systems, Legislative Decree 192/05 - the implementation of Directive 2002/91/EC regarding energy yields in building - (and the subsequent integration with Legislative Decree 311/06), annex I article 12, confirmed by Presidential Decree no.59/2009 (Art. 4, paragraph 6-c), prescribes the installation of devices for automatically adjusting the temperature in individual rooms or areas with the same characteristics of use and exposure, in order to avoid the risk of over-heating due to the added effects of solar radiation and free indoor energy supplies.

Operation

The operating principle is very simple: the variation in room temperature leads to a variation in the volume of liquid contained in the sensor of the thermostatic head. This volume change causes the movement of an internal mechanism and the resulting closure or opening of the valve, hence the modulated flow rate of water entering the heating element. When the temperature in the room is approaching the required value, the head gradually closes the valve, letting through just the minimum amount of water needed to keep the room temperature constant. This means guaranteed energy savings. The Giacomini R468C thermostatic head is designed to be applied exclusively on Giacomini valves of the TG, D, F series.

Technical data

- Temperature range in combination with the valve body: 5÷110 °C
- Max. working pressure in combination with the valve body: 10 bar
- Maximum differential pressure in the valve:
 - 1,4 bar (1/2")
 - 0,7 bar (3/4")
- Min. calibration with thermostatic head 8 °C in position *
- Max. calibration with thermostatic head 28 °C in position *
- Mechanical lockout position (shut-off): fully closed in position "0".

Valve size	Nominal flow rate qmNH	Shutter authority <i>a</i>
3/8"	150 kg/h	0,892
1/2"	150 kg/h	0,924
1/2" (R415TG, R435TG)	150 kg/h	0,832
3/4" (R401D, R401F, R421F)	240 kg/h	0,873
3/4" (R402D, R402F, R422F)	240 kg/h	0,897

C – declared hysteresis: 0,23 K

D – influence of the declared differential pressure: 0,15 K

W – influence of the declared water temperature: 0,26 K

Z – declared response time: 25 min



NB.

The declared values refers to the condition of installation of R468C thermostatic head on Giacomini valve bodies TG, D, F series.



NB:

The thermostatic head is fitted with an indication in Braille of the number 3 on the knob, and the + and - signs are also raised, so the adjustment can also be made by blind and/or partially-sighted people.

Dimensions

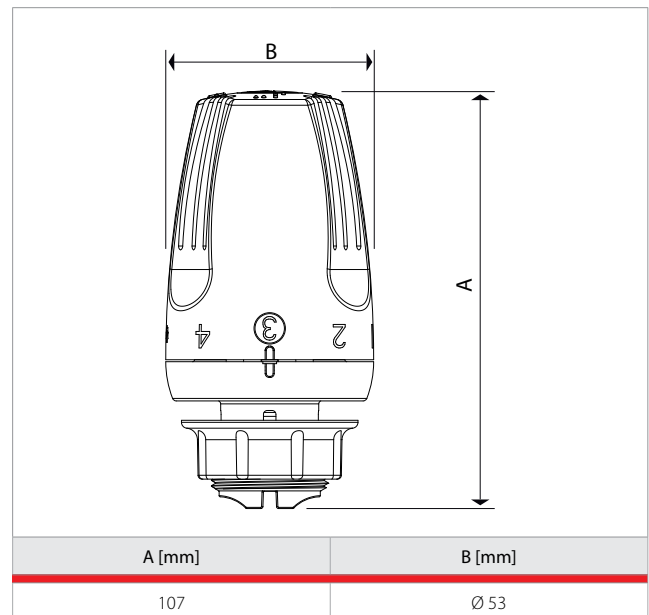



Installation



Warning.
The thermostatic head with the adapter, is individually wrapped.
To avoid damaging the adapter, **do not bring** the thermostatic head in the fully closed position **before** installing the adapter on the valve body.

Do the following operations to install the thermostatic head:

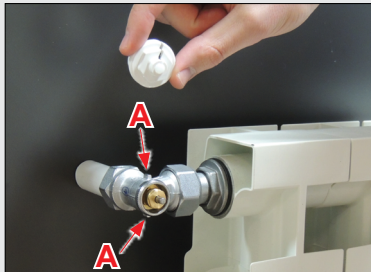

1) Adaptor installation

Take the adaptor and install it on the valve body, by hooking it to the reference pegs (A) on the valve itself.

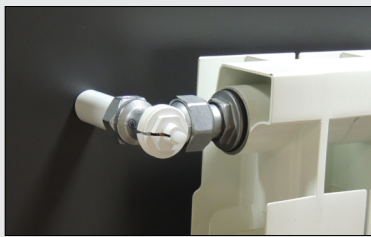

2) Installations of thermostatic head

In order to install correctly the thermostatic head, proceed as follows:

- 1) Bring the thermostatic head to the maximum opening position.
- 2) Put the thermostatic head close to the adaptor.
- 3) Screw the threaded ring nut by pressing gently on the thermostatic head. Apply a torque not exceeding 18 Nm.
- 4) Bring the thermostatic head to the wanted regulation position.



Head regulation

The correct position of the R468C thermostatic head is obtained beforehand, by referring to the table that combines the number on the knob with corresponding room temperatures verified in a thermostatic chamber with a heating element in perfect operating conditions.

If the radiator is positioned where there is cold air or draughts, the calibration temperature will not correspond to the average room temperature because the head sensor is influenced by the local temperature and therefore commands the closure of the valve too early or not at all. In these cases, the position of the knob must be readjusted with the aid of a mercury thermometer positioned in the middle of the room. If, for example, the head is in position 3 and the room temperature is lower than the 20 °C envisaged while the system is working, this means the valve has been prematurely closed due to local excess temperature. To solve the problem, turn the knob slightly until it is halfway between number 3 and number 4. Vice versa, if the temperature is higher than the 20 °C envisaged when the head is in position 3, this means the bulb is positioned in a cold draught and therefore keeps the valve open. In this case, turn the knob until it is halfway between number 2 and number 3.

If the room where the thermostatic head is installed is not used, you can ensure the best energy savings by turning the knob to position * (corresponding to the 8 °C anti-freeze protection temperature).

In the case of radiator maintenance, you can use the thermostatic head "shut off" function: position "0" corresponding to mechanical closure allows you to shut off the radiator valve without having to disassemble the thermostatic head and reassemble the manual handwheel.

Position	0	*	1	2	3	4	*
Adjusted temperature [°C]	SHUT OFF	8	12	16	20	24	28



Warning.

To avoid excessive loads on the seal gasket of the thermostatic bonnet (with the resulting risk of jamming and locking) during the summer, it is a good idea to place the knob in the fully open position marked by the symbol *.

The values shown in the table refer to the optimum conditions obtained in a climatic chamber. In the room itself, these values may be altered by factors such as the type of installation, the environmental conditions, the degree of insulation of the building, and certain characteristics of the heating element.



Knob opening limit and locking

The operations of limitation and locking of the handle, have to be effected with head mounted on the valve body.



1. Turn the knob to the position that you want to lock/slice, and disconnect the limiter ring with the aid of a screwdriver.
(example: in this figure, you want to lock/slice the adjustment at position 3).



2. Rotate the limiter ring. Using the "T" notch (see figure) as a reference, connect the ring in line with one of the 3 icons on the back of the knob:

1. * →
2. 0 →
3. ⚙ lock

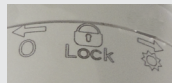

3a. Slicing the opening of the thermostatic head:



• in position 0 → the required position is limited from position 0 up to the required number (example: fix the knob in position 3 and the limiter ring in position 0 →. In this way, the head can be fully closed, or fully opened up to 3).



• in position * → the required position is limited from position 0 up to the required number (example: fix the knob in position 3 and the limiter ring in position * →. In this way, the head can be fully opened, or fully closed up to 3).

3b. Locking the adjustment range:



• in the ⚙ lock position, the adjustment is locked in the required position (example: fix the knob in position 3 and the limiter ring in the ⚙ lock position. In this way, the head is locked in position 3 and cannot be adjusted).

Nota.

Whether necessary to reset the limiter ring to the default position:
1) put the notch (T) in correspondence of "reset" marking.
2) set the position n° 3 of thermostatic head in correspondence of "reset" marking.

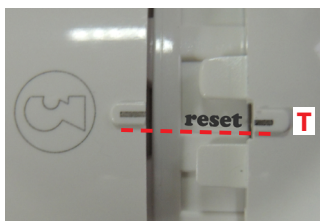

Losses of pressure

The diagrams showing loss of pressure are obtained with the thermostatic head in position 3 and a difference between the room temperature and set temperature equal to 1K and 2K (curves s-1K and s-2K), and with the thermostatic head fully open in position * (corresponding to the maximum valve opening).

With 3/8" - 1/2" valves

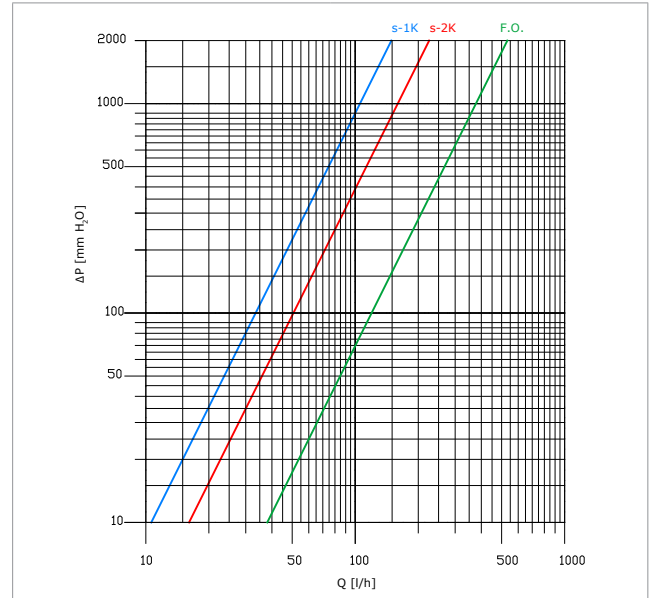

Condition	Kv
s-1K	0,33
s-2K	0,51
F.O.	1,26

With 3/4" valves (R401D - R401F - R421F - R402D - R402F - R422F)

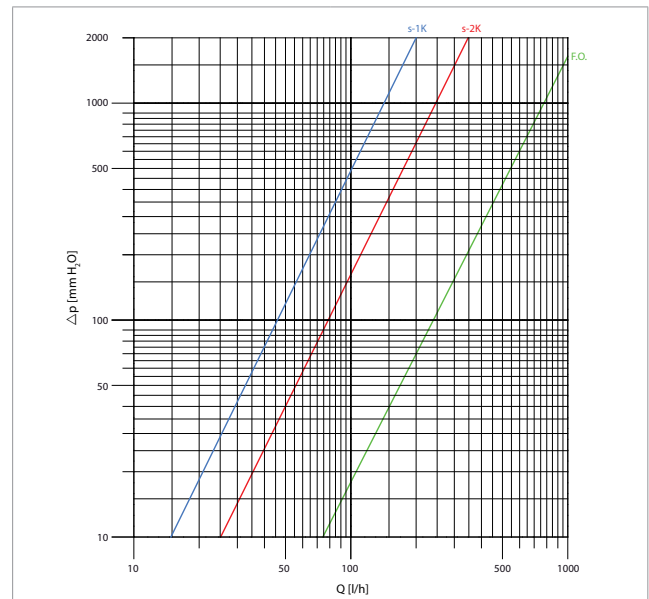

Condition	Kv
s-1K	0,44
s-2K	0,80
F.O.	2,37



Product specifications

R468C

Thermostatic head, with liquid sensor, complete with adaptor. Adjustment positions from * a * corresponding to a temperature range of 8÷28 °C. Position "0" for shut-off function. Possibility to lock or slice the opening and/or closure via the limiter ring supplied. Suitable for valves with thermostatic option of the TG, D, F series. Temperature range in combination with the valve body 5÷110 °C. Max. working pressure in combination with the valve body 10 bar. KEYMARK certification – TELL energy class A, comply to RT2012 directive - Certità with value of *variation temporelle* VT 0,22. Numbering in Braille, enabling blind and/or partially-sighted people to make the necessary adjustments.

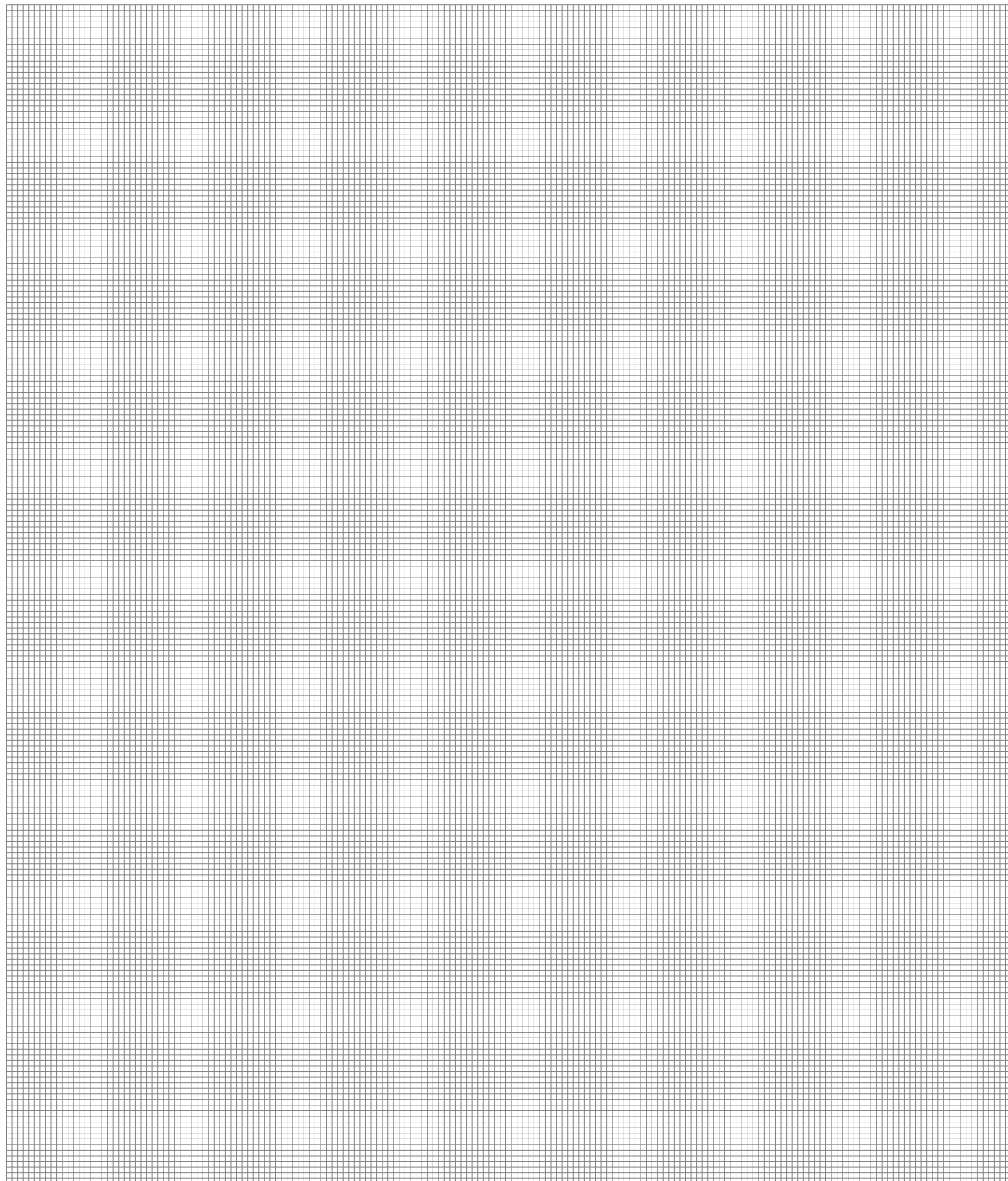

Additional information

For additional information please check the website www.giacomini.com or contact the technical service: ☎ +39 0322 923372 📠 +39 0322 923255 ✉ consulenza.prodotti@giacomini.com
This pamphlet is merely for information purposes. Giacomini S.p.A. retains the right to make modifications for technical or commercial reasons, without prior notice, to the items described in this pamphlet. The information described in this technical pamphlet does not exempt the user from following carefully the existing regulations and norms on good workmanship.
Giacomini S.p.A. Via per Alzo, 39 - 28017 San Maurizio d'Opaglio (NO) Italy